

Finding and Killing Receive Noise

Jim Brown K9YC

k9yc@arrl.net

**Don't Bother Taking Notes –
These slides and the tutorial from
National Contest Journal are on
my website**

<http://k9yc.com/publish.htm>

Two Major Kinds of RFI

- **RFI From our ham station**
 - **TVI, Audio/Video Equipment**
 - **Telephones, Computers, Data**
 - **Security Systems, Garage Doors**
- **RFI (Noise) To our station**
 - **Digital Equipment**
 - **Power Supplies, Chargers**
 - **Motor Controllers**
 - **Power Line Equipment Failures**

**This talk is about RFI to our
stations**

What We're Going To Talk About

- **Common sources of RF noise**
- **How to recognize them**
- **How noise is transmitted**
- **How noise is received**
- **How to find the noise source**
- **How to kill the noise source**
- **What noise you can't kill**

Why Killing RX Noise Matters

- I've worked a lot of stations that didn't move my S-meter
- 10 dB less noise makes a 100W signal seem like a 1kW signal
- 20dB less noise makes 1W seem like 1kW
- You can't work 'em if you can't hear 'em!
- It's really worth it to chase and kill RX noise

Why Killing RX Noise Matters

- My challenge working VK0EK on 160M was hearing them through my local noise
- I heard them just well enough to call on three different days, each time they heard me, but they faded into the noise before I heard them come back to me
- Not until that third day did I hear them well enough to know they had come back to me so I could give them a report

RFI To Ham Radio

- **RF noise is generated by equipment**
- **The wires inside equipment, and cables that interconnect equipment, are antennas, and can transmit that RF noise**
- **Our antennas receive it like any other signal**
- **Our AM and FM radios may also hear that noise**

RFI To Ham Radio

- **RF noise rarely comes in on the power line, so power line filters are usually wasted money**
- **What does matter is proper bonding and grounding at the power entrance and throughout the building**
- **More about that later**

Two Fundamental Types of Noise

- **Impulse Noise** – something is arcing
 - Often called a “spike”
 - An impulse has infinite harmonics
 - An impulse contains all frequencies
- **Electronic Noise**
 - Harmonics of square or rectangular waves used by equipment
 - Noise occurs only at those harmonic frequencies

Common Sources of Impulse Noise

- **Lightning (static is distant lightning)**
- **The power company's system**
 - **Broken or dirty insulators**
 - **Loose or broken fittings and connectors**
 - **Failing transformers**
- **Defective neon signs, street lights**
- **Defective doorbell transformers**
- **Electric fences**
- **Fluorescent lighting**

Common Sources of Electronic Noise

- **Switch-Mode Power Supplies (SMPS), including battery chargers, LV lighting**
- **Variable speed motor controllers**
 - **Washing machines, HVAC systems, exercise machines, elevators**
- **Ballasts for fluorescent and other lighting**
- **Equipment with digital circuitry**
 - **Computers, audio and video gear, ham gear, appliances**
- **Plasma TV sets**

What is Electronic Noise?

- **Most electronic noise consists of harmonics of oscillators or clocks that produce square or rectangular waves**
- **Square waves have many harmonics**
- **Fast rise/fall times = strong harmonics**
- **Harmonics in digital equipment are stable in frequency**
- **Harmonics from power equipment are not stable – they drift**

Traditional “Linear” Power Supplies

- **Consist of a transformer, rectifier(s), filter capacitor, and maybe a regulator**
- **AC current flows in pulses that recharge the capacitor at the peak of each 60 Hz cycle**
- **Harmonics present only at audio frequencies – 120 Hz, 180 Hz, 240 Hz, 360 Hz, 420 Hz, 480 Hz, 540 Hz, etc.**

Switch-Mode Power Supplies

- **More efficient, lighter, (and cheaper) than traditional linear supplies**
- **Start with a simple linear supply – transformer, rectifier, small filter cap**
- **Produces DC with a lot of ripple**
- **That DC is used to generate a square wave, typically 10-30 kHz**
- **Rectify the square wave and filter it**

Switch-Mode Power Supplies

- **The square wave has fast a rise time (more efficient, less dissipation in devices)**
- **Fast rise time = many strong harmonics**
- **Harmonics spaced at 2x the square wave frequency**

Switch-Mode Power Supplies

- **Square wave frequency is free-running**
 - It drifts – is not controlled by a clock
 - Is modulated by random noise (dithered) and 120 Hz ripple
- **Dither – causes power to be split between carrier and sidebands**
- **Carrier is weaker, so helps meet FCC limits for emissions at a single frequency**
- **Carrier “wobbles” in frequency**
- **Sounds like a “growl”**

Typical noise signature of a switching power supply

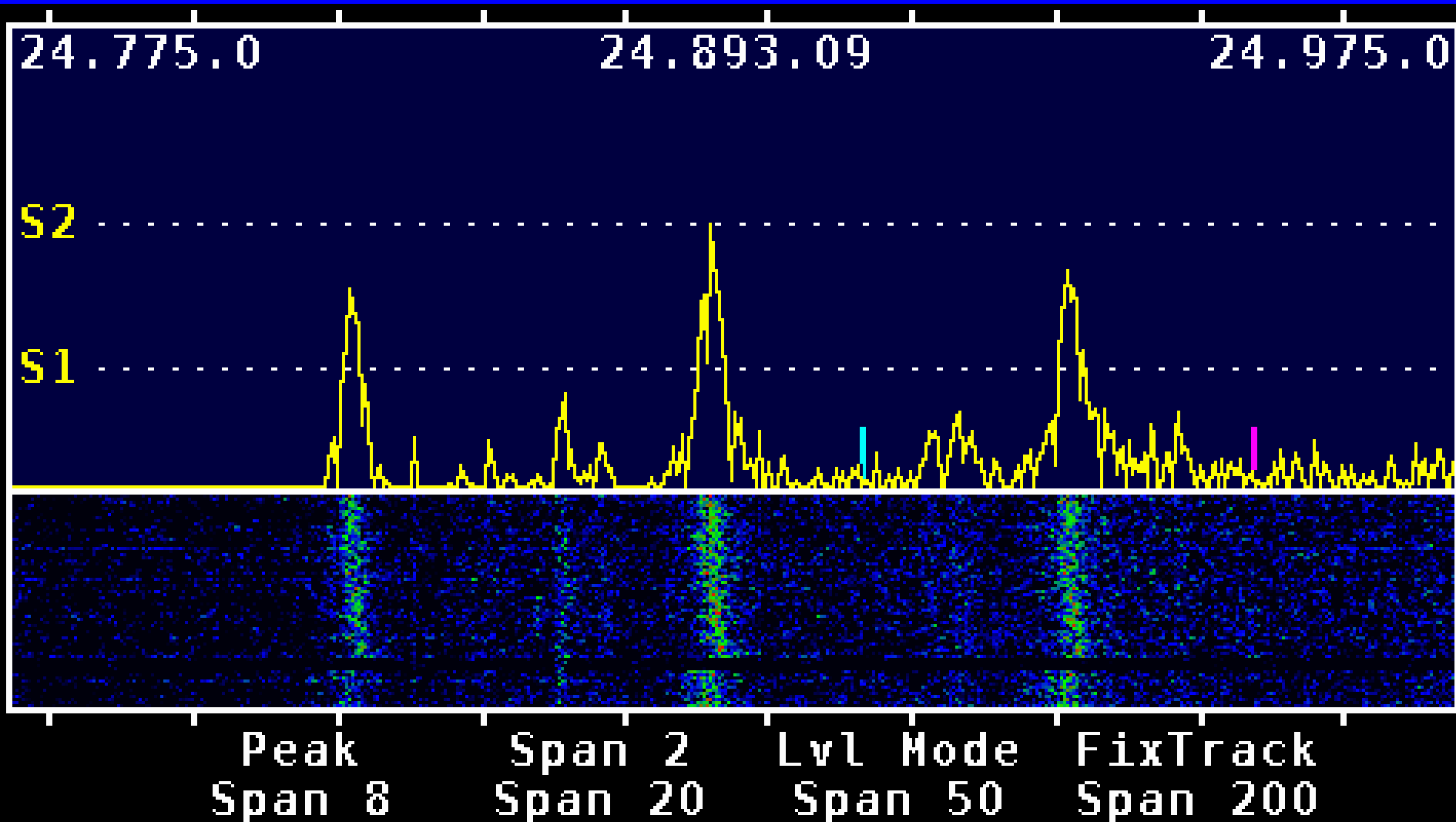

The same switching PSU drifting after being switched on

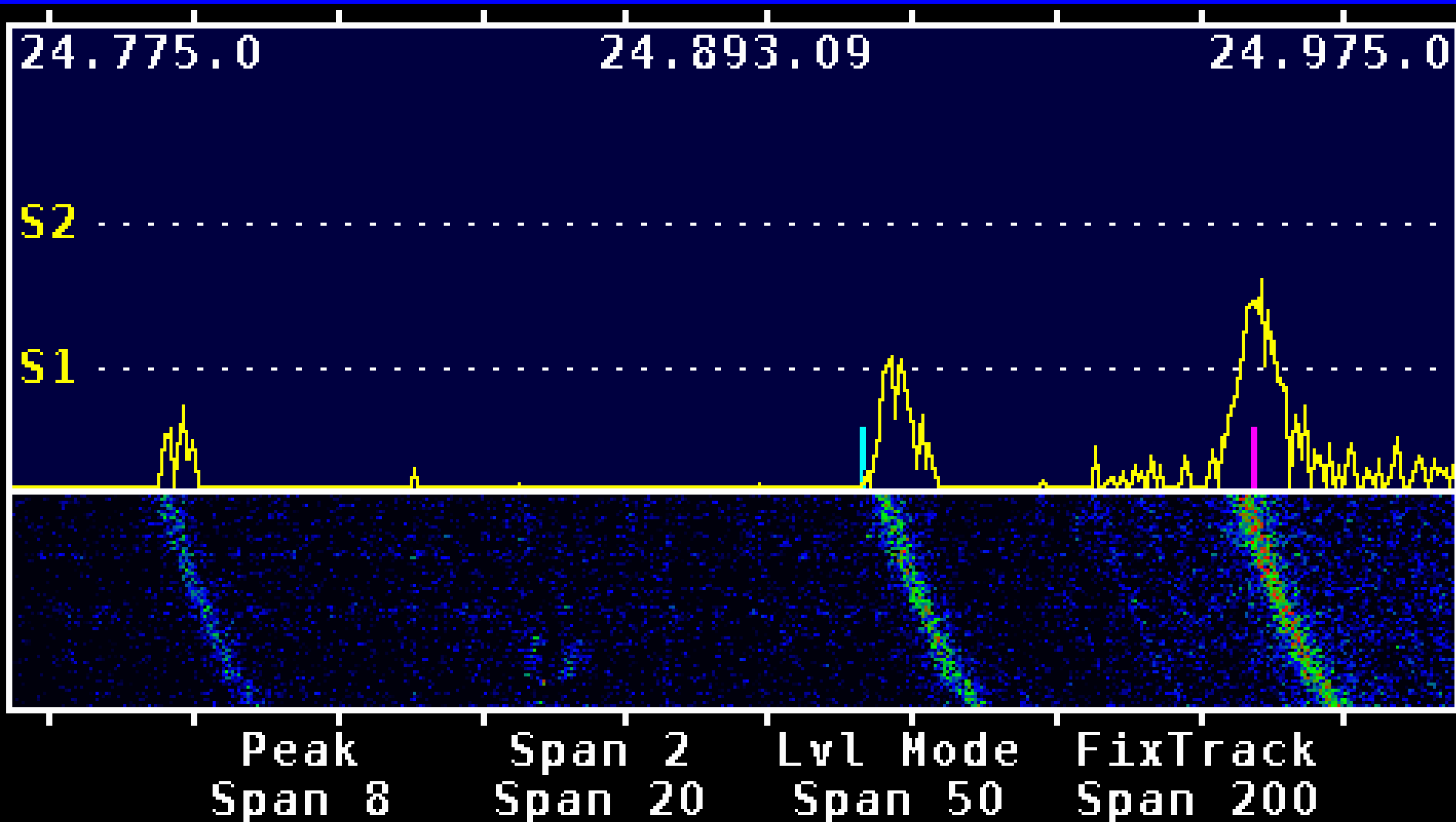

A closer look at one of the peaks

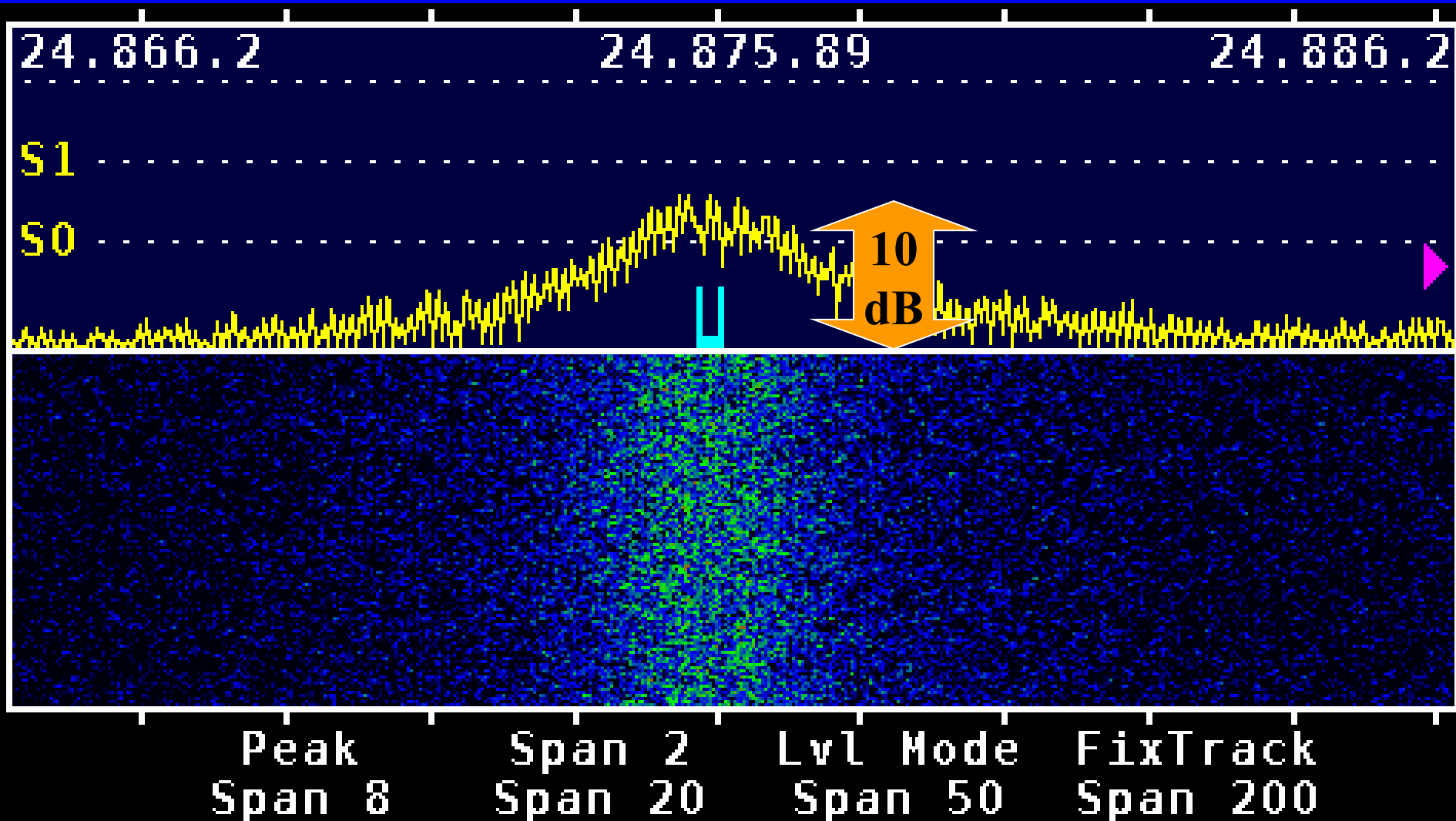

Same picture, a minute later

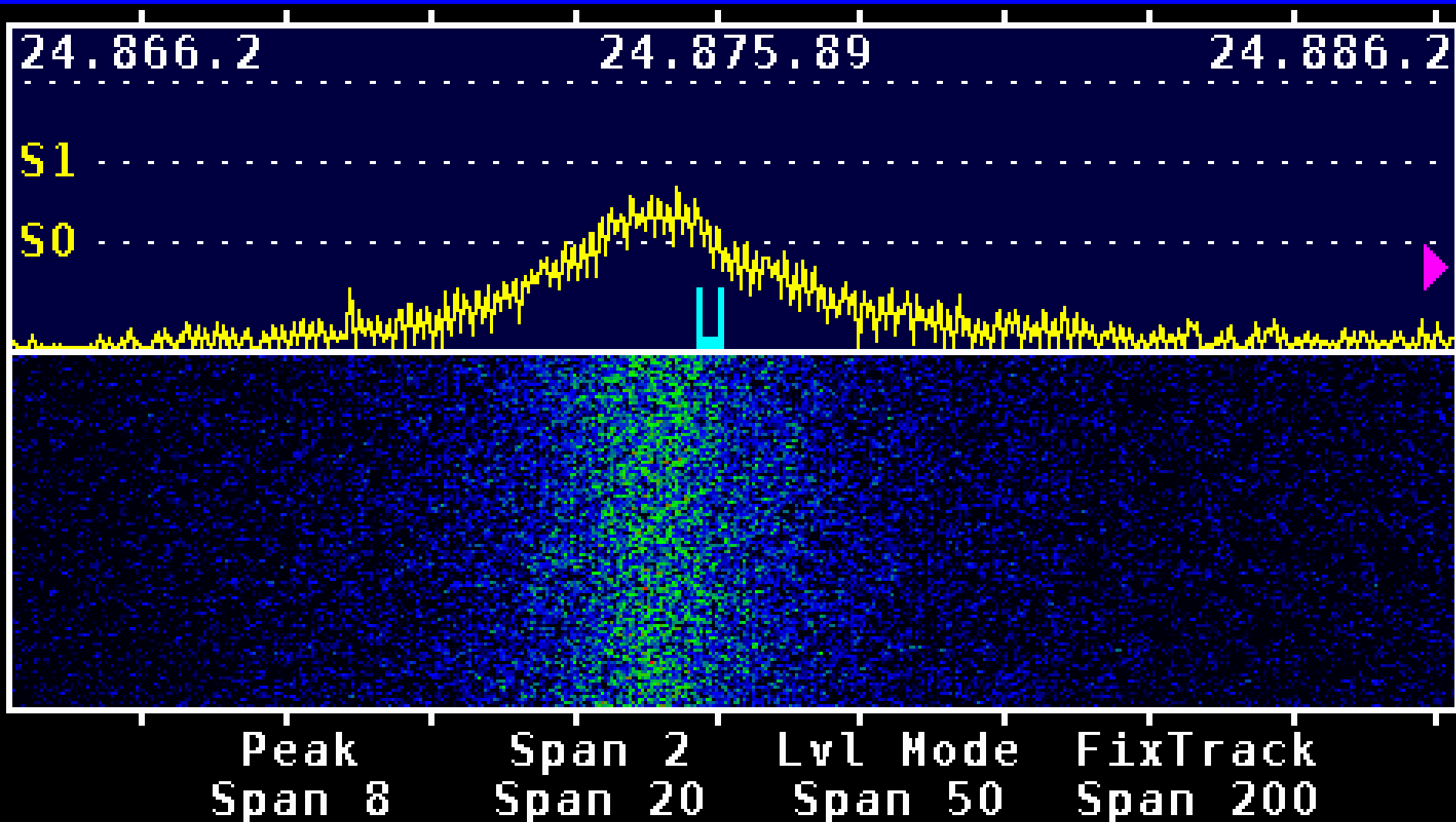

And another minute later

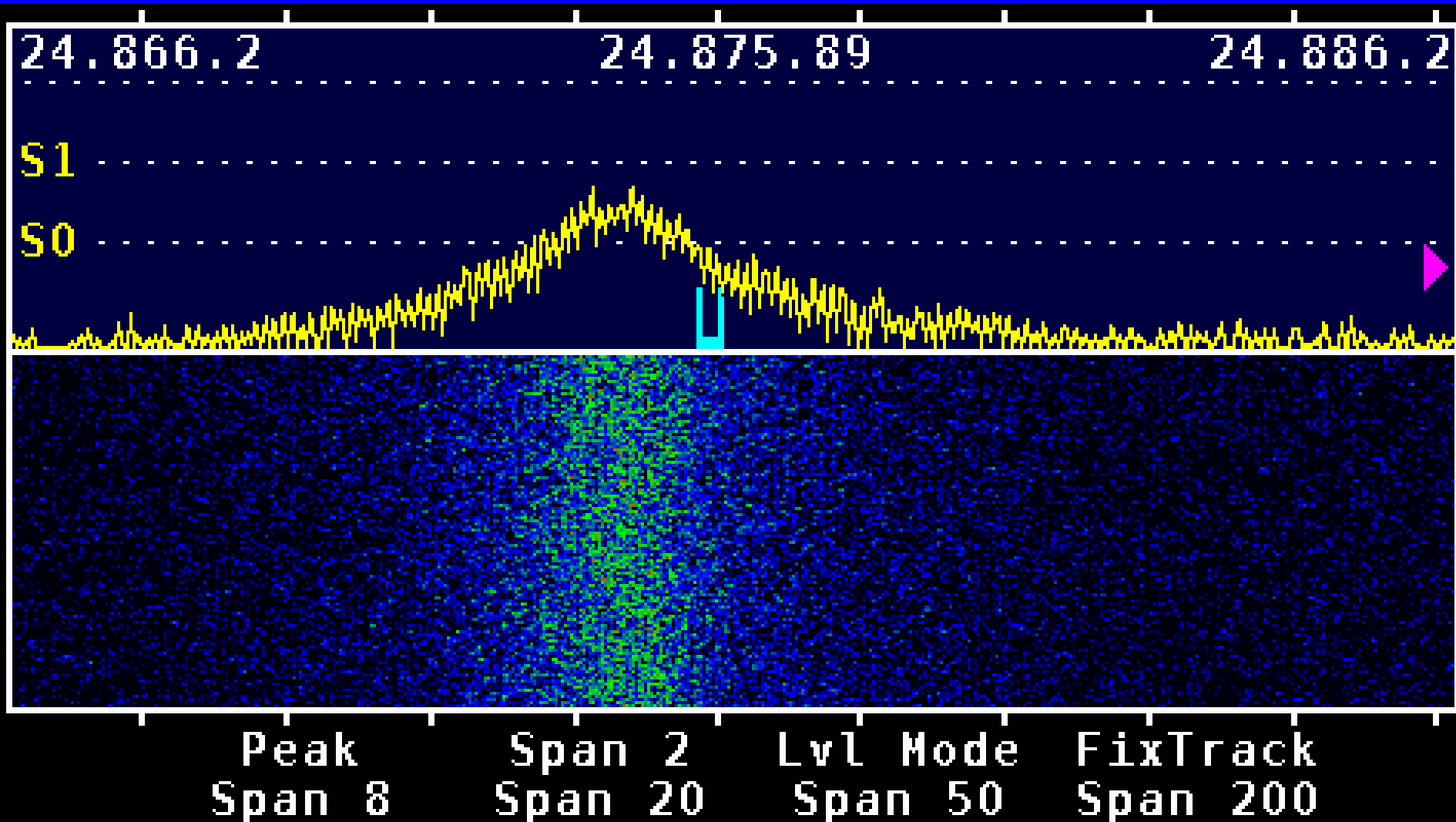

And another minute later

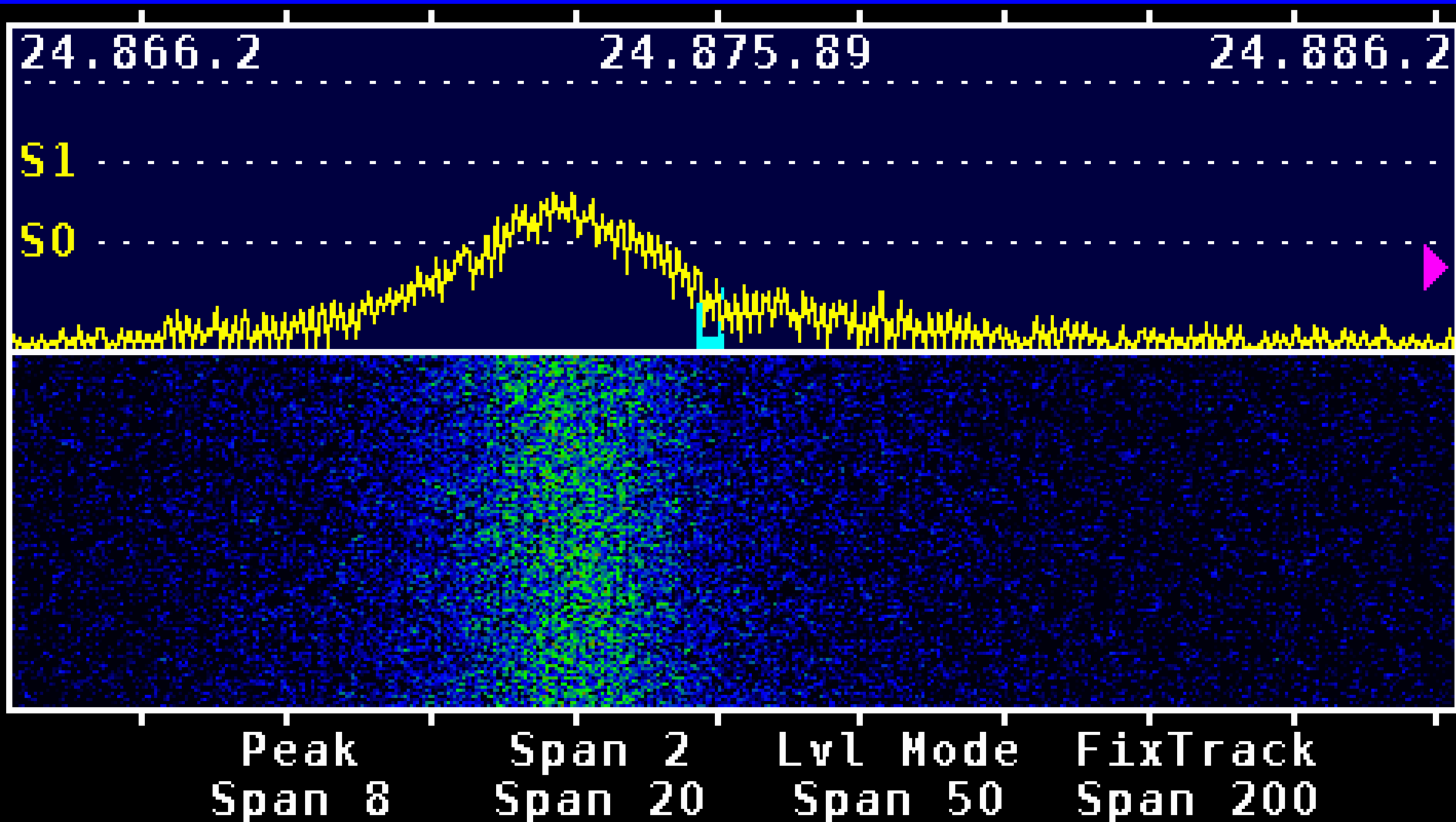

And another minute later

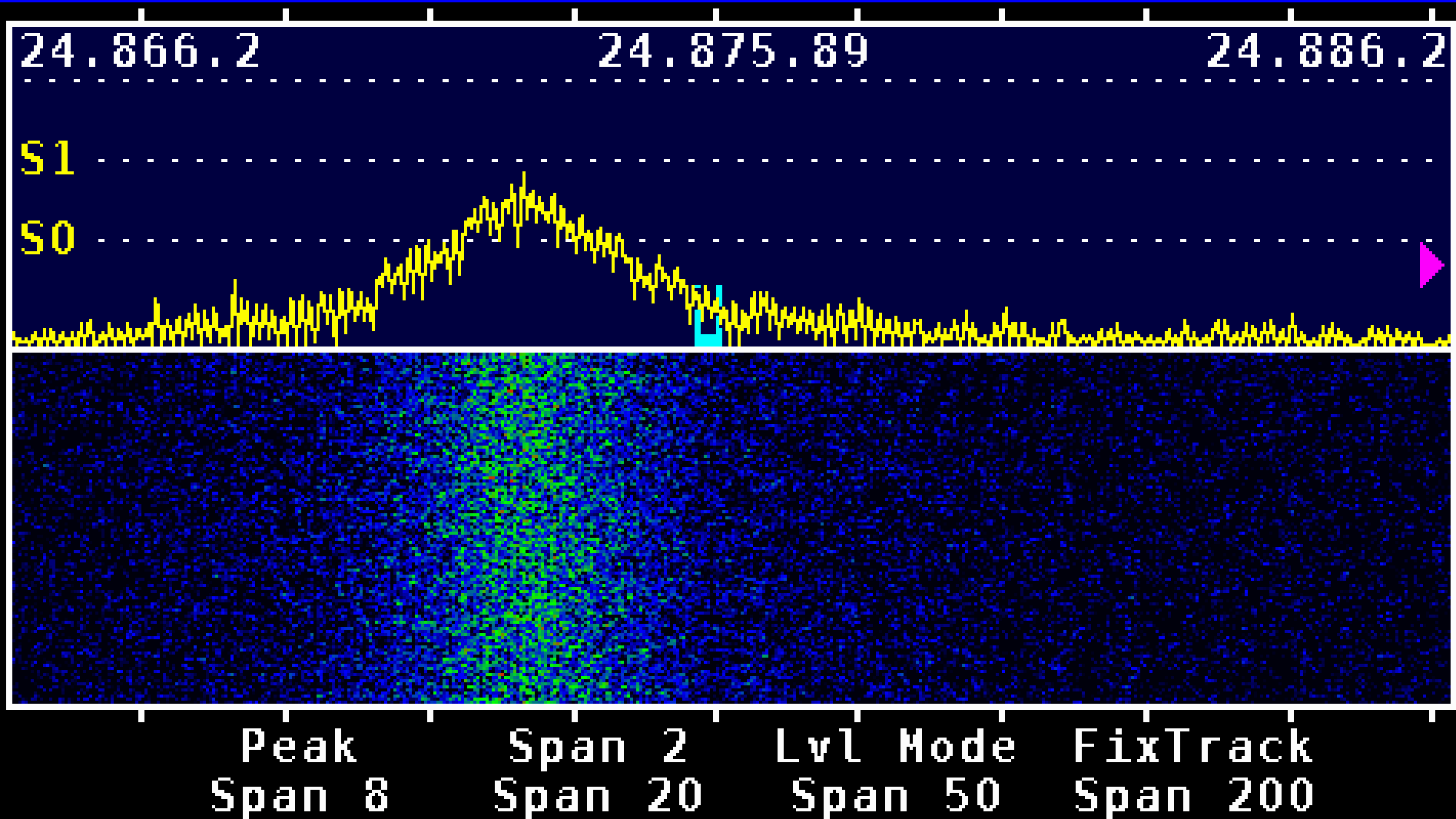

That's the 33V PSU for my SteppIR

- I'd already suppressed the noise by more than 20dB before I took these pictures!**
- And that wasn't nearly enough**

Noise From Digital Equipment

3.500.0 3.603.45 3.700.0

Ref Lvl (-dBm):
109

3.5 – 3.7 MHz Daytime

Taller spikes are digital signals, small humps are SMPS

**S
M
P
S**

**S
M
P
S**

**S
M
P
S**

**S
M
P
S**

**S
M
P
S**

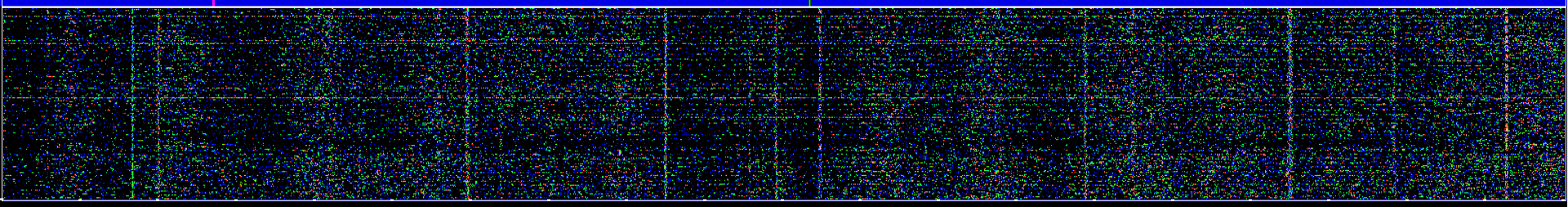

Impulse Noise – Static Crashes on 160M

1,800 – 1,860 kHz

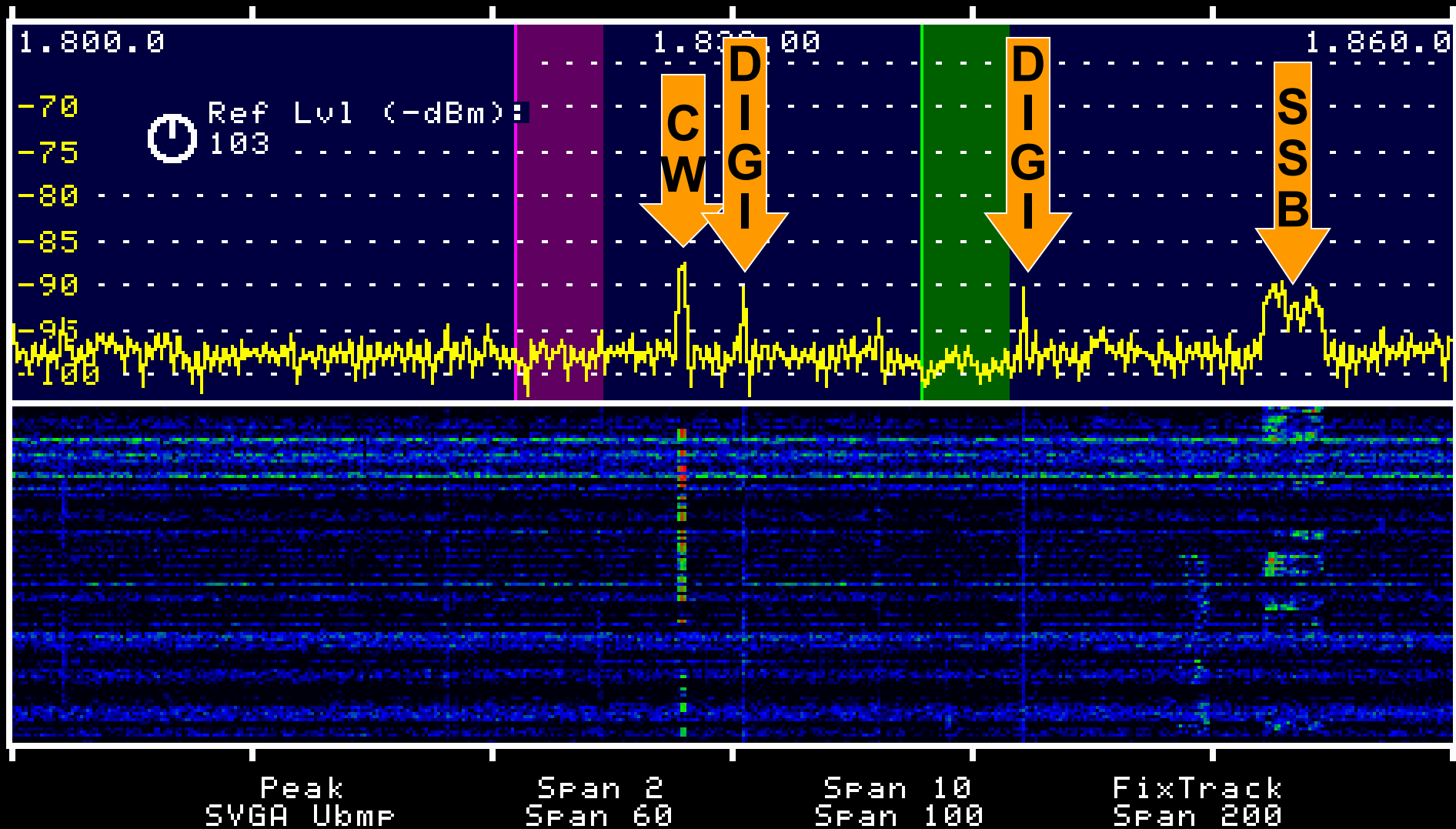

Impulse Noise – Static Crashes on 160M

1,800 – 1,860 kHz

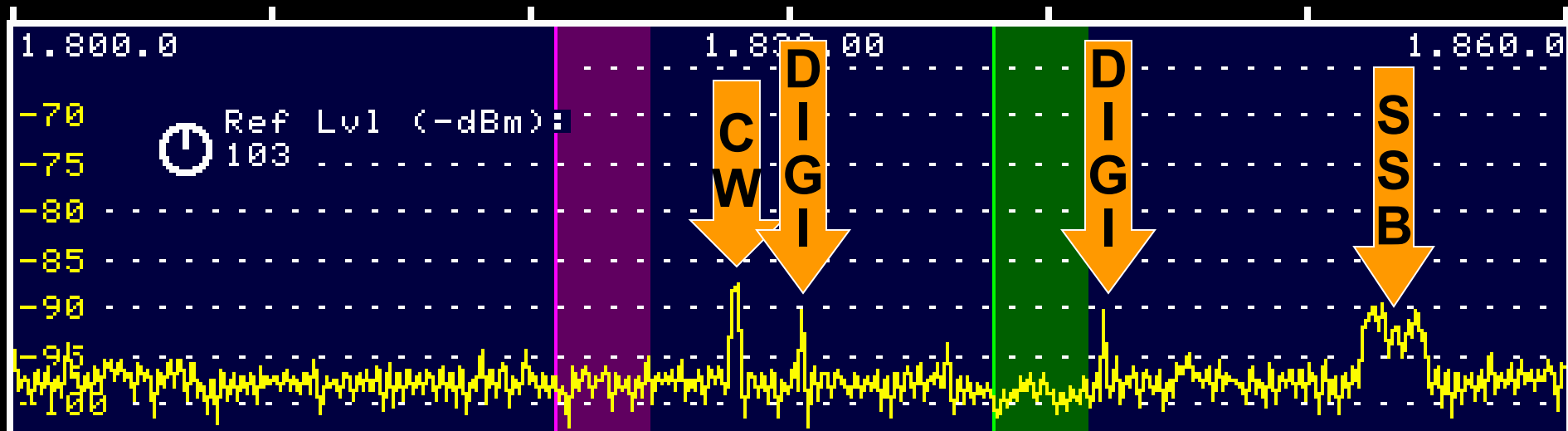

Horizontal Lines in Waterfall = Impulse Noise

Peak
SVGA Ubme

Span 2
Span 60

Span 10
Span 100

FixTrack
Span 200

Impulse Noise – Static Crashes on 160M

1,800 – 1,860 kHz

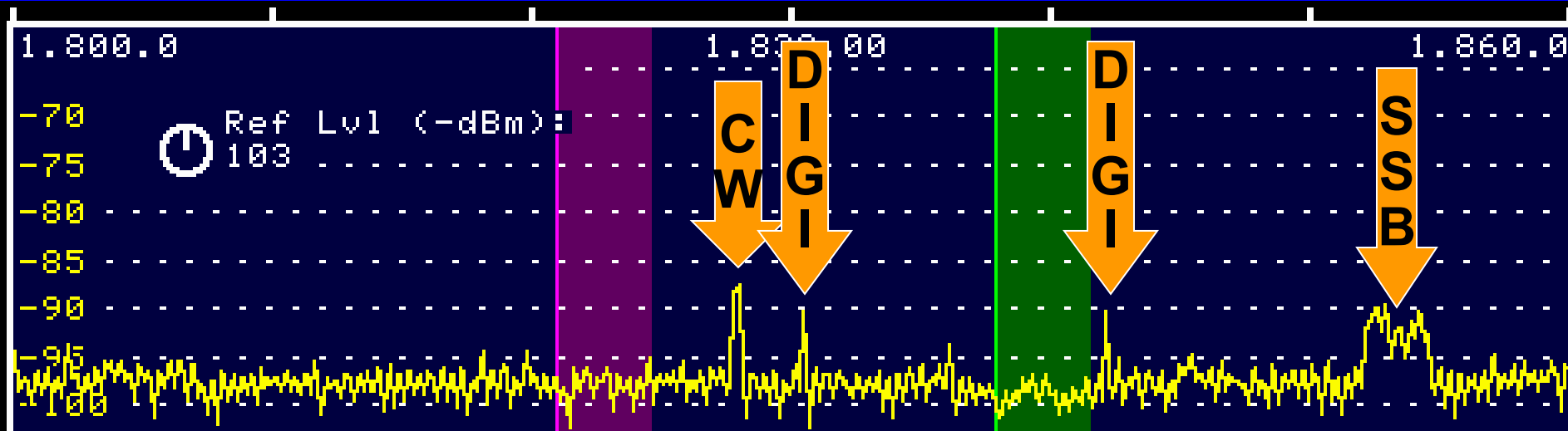

Vertical Lines in Waterfall = Electronic Noise
(and Signals)

Peak
SVGA Ubme

Span 2
Span 60

Span 10
Span 100

FixTrack
Span 200

Switch Mode Power Supplies

- **Low-voltage lighting, including track lighting**
- **Battery chargers**
- **Wall warts, line lumps**
- **Power supplies built into most modern equipment**
 - **Computers, home entertainment systems**
 - **Appliances**
 - **Almost everything that you've bought in the last 10 years and plugged into 120VAC**

Spectrum Displays Are Great RFI Tools

- **SDR receivers are now very inexpensive**
- **Use with free software on Windows, Mac, Linux, Android, Raspberry Pi**
 - **Study the panadapter display**
 - **Spectrum, waterfall**
 - **Listen to detected audio**
 - **Save data, share it, print it**
- **USB connection to computer provides power and data connection**

SDRPlay \$130 at HRO

- 12-bit
- 100 kHz – 2 GHz
- Display up to 9 MHz
- Use with free software on Windows, Mac, Linux, Android, Raspberry Pi
- USB connection to computer provides power and data connection
- Antenna input is SMA connector
- Setup and operation is user-friendly



FunCube Dongle Pro+ \$175



- **16-bit, Displays up to 192 kHz**
- **150 kHz – 260 MHz, 410 MHz – 2 GHz**
- **Free software on Windows, Raspberry Pi**
- **USB for power and data**
- **Antenna input is SMA connector**

ANAN 10E 10W Transceiver \$ 965

- 14-bit
- Displays up to 10 MHz
- 10 kHz – 55 MHz
- 12VDC supply
- Ethernet to computer
- PowerSDR mRX software by NR0V runs on Windows
- Software is free
- Antennas on SMA connectors
- Recently discontinued



P3, PX3 Panadapter for K3, KX3

\$700 (kit)

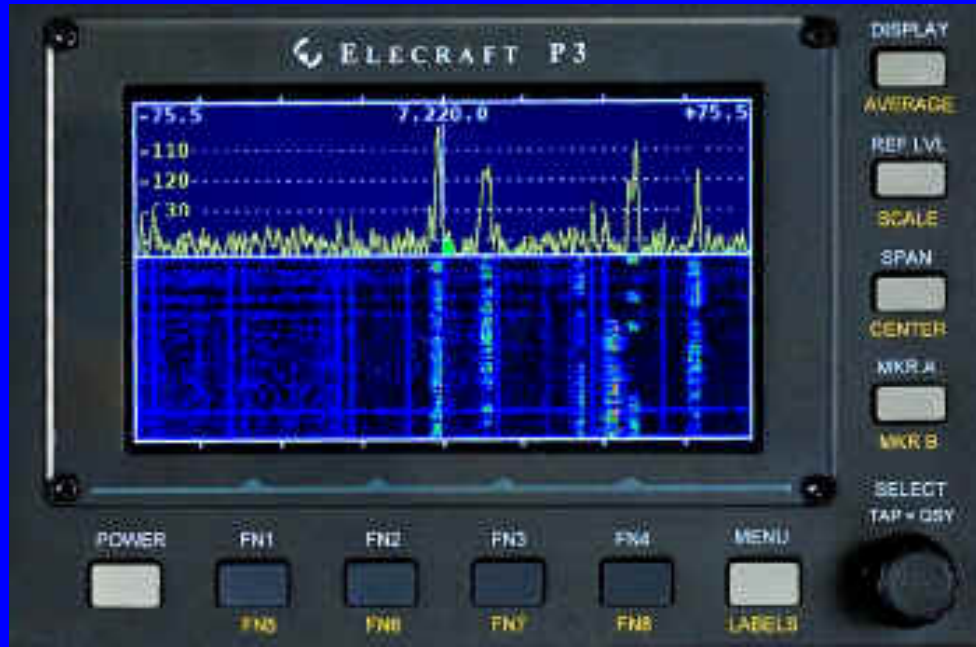

\$500 (kit)

P3, PX3 Panadapter for K3, KX3

- **100 dB dynamic range, 80 dB display**
- **Displays 2 kHz to 200 kHz**
- **Takes signal from transceiver IF**
- **RS232 interface to K3, K3S, KX3 reads operating frequency**
- **P3 works with other rigs that provide IF out, but no frequency data**

Spectrum Displays as RFI Tools

- Use to identify type of noise
- Impulse noise
 - Power line noise, neon sign, electric fence
- Electronic noise
 - Switching power supplies
 - Variable-speed motor controllers
 - Digital equipment
 - Cable/DSL modem leakage
- Also very useful when chasing the noise

How To Use Spectrum Displays

- Set for a lot of averaging to emphasize signals, suppress random noise
- Set bottom of display to band noise floor
- Set top of display to strongest signals
- Waterfall is the most useful part of display
- Set for large waterfall
- Set waterfall to show at least 2 minutes
- Use much longer waterfall times to view on and off times of noise sources

A

waterfall should be much larger)

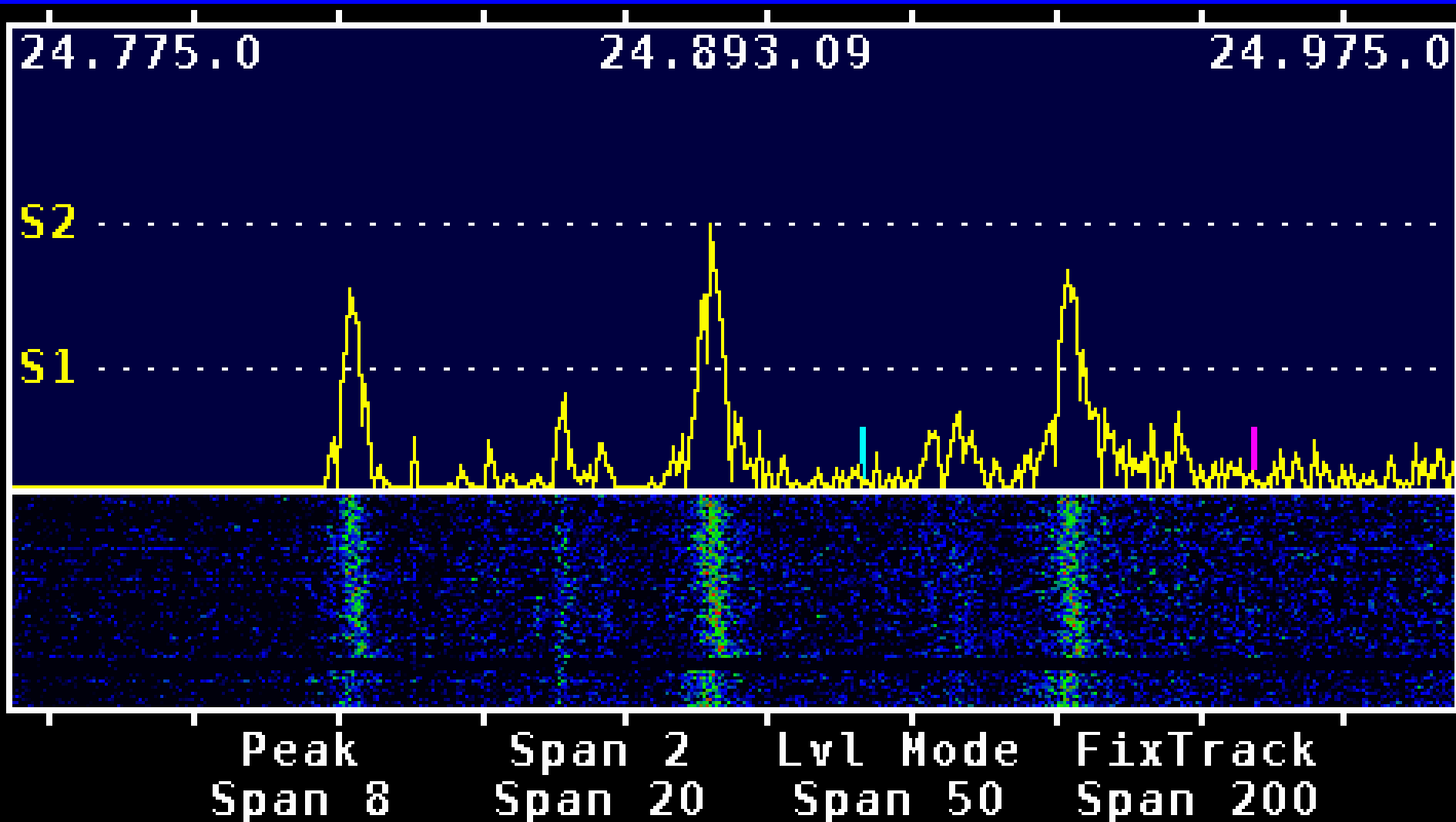

What is Band Noise?

- **Band noise is propagated from distant sources like any other radio signal**
- **You would hear it on a quiet mountaintop**
- **Sources are not near you – come from hundreds or thousands of miles away**
- **Static crashes from distant thunderstorms**
- **Local noise from where the band is open to**
 - **Power line noise, street lights, BPL**
 - **Other random noise sources**

How Bad Is Your Noise Problem?

- **Band noise should increase when the band is open, be quiet when it is dead**
 - **10-20dB increase is typical**
 - **Noise on 40, 80 and 160 should be lower during the day, increase 10-20dB at night**
 - **Higher bands usually open more during the day, sometimes evenings too**

How Bad Is Your Noise Problem?

- **Band noise should increase when the band is open, be quiet when it is dead**
 - **10-20dB increase is typical**
 - **Noise on 40, 80 and 160 should be lower during the day, increase 10-20dB at night**
 - **Higher bands usually open more during the day, sometimes evenings**
- **If you don't hear this difference, your local noise level is way too high!**

Measuring RFI To Your Station

- **Most S-meters not very accurate**
- **One S-unit should be 6dB, but for most rigs it's more like 3-4 dB**
- **A properly aligned K3 and many SDRs are pretty accurate if well calibrated**
- **Our objective is to reduce local noise enough that we see at least 10 dB noise increase when the band is open**
 - **2 S-units on a K3, KX3, most SDRs**
 - **3 S-units on most other radios**

Before You Start

- **Clean up your own station First!**

Clean Up Your Station First

- **Always start with your own station, wiring it to minimize noise pickup**
 - **Practice proper bonding in your shack and throughout your home**
- **Use a ferrite choke at the feedpoint of every antenna**
- **Avoid “balanced” line**
- **Avoid “off-center-fed” antennas**

Use Antennas That Pick Up Less Noise

- **Avoid “balanced” line**
 - It cannot be choked to kill noise picked up on the feedline
- **Avoid “off-center-fed” antennas**
 - They are badly unbalanced, so the feedline becomes part of the antenna
 - They cannot be choked to kill noise picked up on the feedline
- **Balanced tuners are not a solution**

Antenna Designs for Yesterday

- **All-band non-resonant antennas fed with 2-wire line, including both center-fed and off-center-fed wires, were a good idea 50 years ago – they transmit just fine**
- **They are a very bad idea today, when every home has dozens of RF noise sources, simply because they receive more noise**

Antenna Designs for Today

- **Use only coax-fed resonant antennas**
- **Horizontal antennas usually receive less noise than verticals**
- **Higher antennas pick up more signal and less local noise**
- **Directional antennas receive less noise**
 - **except when pointed at a noise source**
- **Always use a good ferrite choke at the feedpoint**

The Biggest Myths

Myth: “I need a better ground”

Fact: The earth is not a sump into which noise is pumped

Fact: A connection to earth almost never reduces noise or RFI, and it will often make it worse, because the “ground wire” can act as an antenna.

Fact: A connection to earth is very important for lightning protection.

The Biggest Myths

Myth: “I need a better ground”

Fact: Proper bonding can reduce noise, makes an installation safer, and is required by LAW (electrical building codes)!

Fact: The people who write those codes are damned smart engineers working to make us safe, not big government intruding on our rights!

The Biggest Myths

Myth: “I need a separate RF ground”

Fact: Separate grounds are unsafe – they can kill someone, increase lightning damage, even start a fire.

Fact: Separate grounds are more likely to cause problems than to fix them.

Fact: BY LAW, all grounds must be bonded together

The Biggest Myths

Myth: “This device is clean – I don’t hear it at my station.”

Fact: The device could be noisy, but other noise is covering it up. Most of us are surrounded by dozens of noise sources.

The Biggest Myths

Myth: “This device is clean – it’s sitting right next to my rig and I don’t hear a bit of noise.”

Fact: Most noise is radiated by wires connected to the noise source and picked up on our antennas. What matters is proximity of the noise source to our antennas, not to our receiver.

Proper Bonding

- **Bond chassis-to-chassis of all the gear in your station with short, fat copper**
- **Chassis-to-chassis should follow signal flow**
 - **Computer to rig**
 - **Audio interface to rig**
 - **Rig to amp, amp to tuner**

Proper Bonding

- **Chassis-to-chassis bonding does not create loops**
- **Star bonding does create loops with the shields of audio cables, control cables, and coax**
- **Those cables often carry noise out of equipment due to poor equipment design (Pin One Problems)**
 - **We'll talk about that later**

Proper Bonding

- **Star-bonding in the shack is not best, because it makes the paths longer, and creates loops with audio, control cables**
- **Bond chassis-to-chassis, then bond one of those chassis (rig or amp/tuner) to building grounds**
- **This bonding kills power line hum and buzz, and is also right for lightning and noise**

Proper Bonding

- **Bond coax shields to a robust entry panel where coax enters your shack**
- **Use lightning protectors at that panel**
- **Bond that panel to local rods and to your shack ground**
- **Bond all grounds together**
 - **Power system, CATV, Telco, satellite, coax entry panel, shack, all rods**

Proper Bonding

- **Study slides for my Pacificon talk a few years ago for all the details**
- **k9yc.com/GroundingAndAudio.pdf**

Finding Noise Sources

What Times of Day Is It Present?

- Use very long waterfall times to see the on and off times of noise sources
- Shows when equipment generating noise is being turned on and off
- Provides clues about possible sources
- Tells us when to look for it
- Study NK7Z's website <http://nk7z.net/>

24 hours on 80M at NK7Z

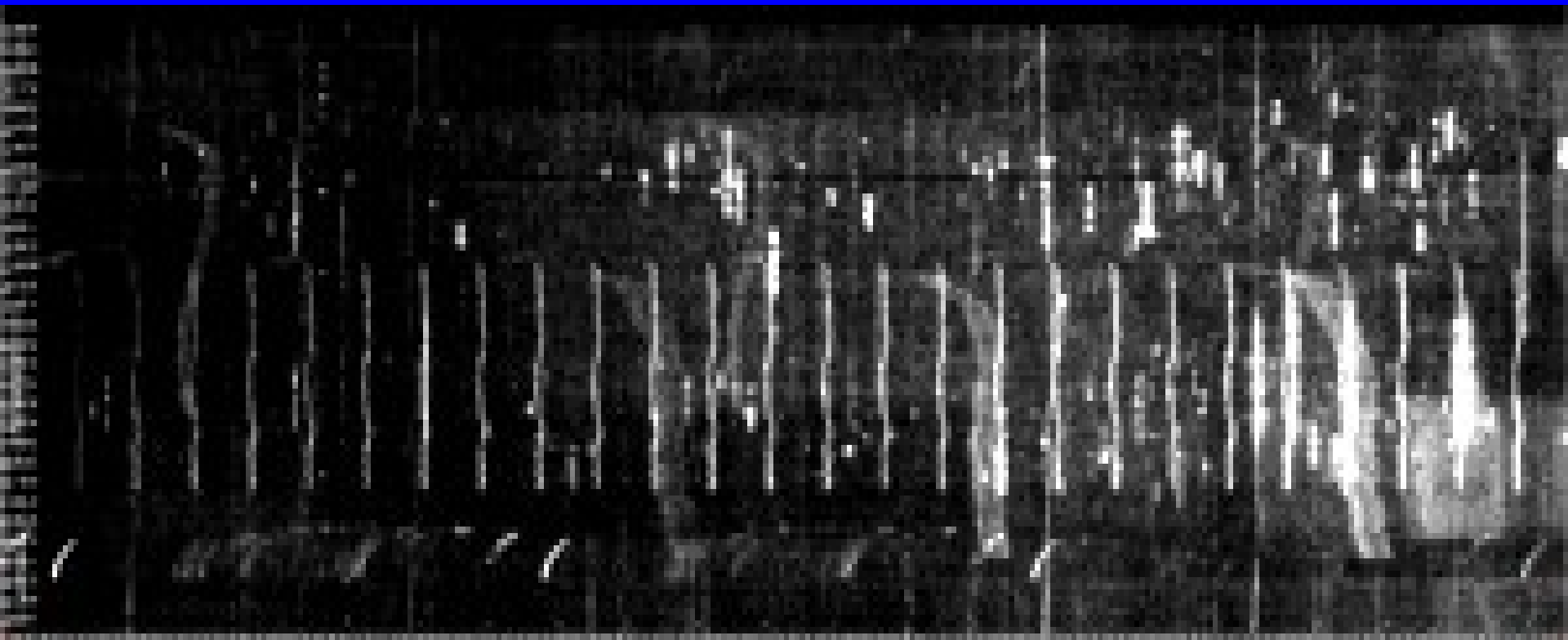

- Vertical “squiggley” lines are a switching power supply turning on and off
- Smearred curvy lines are something else
- Time is shown at left edge of screen

24 hours on 40M at NK7Z

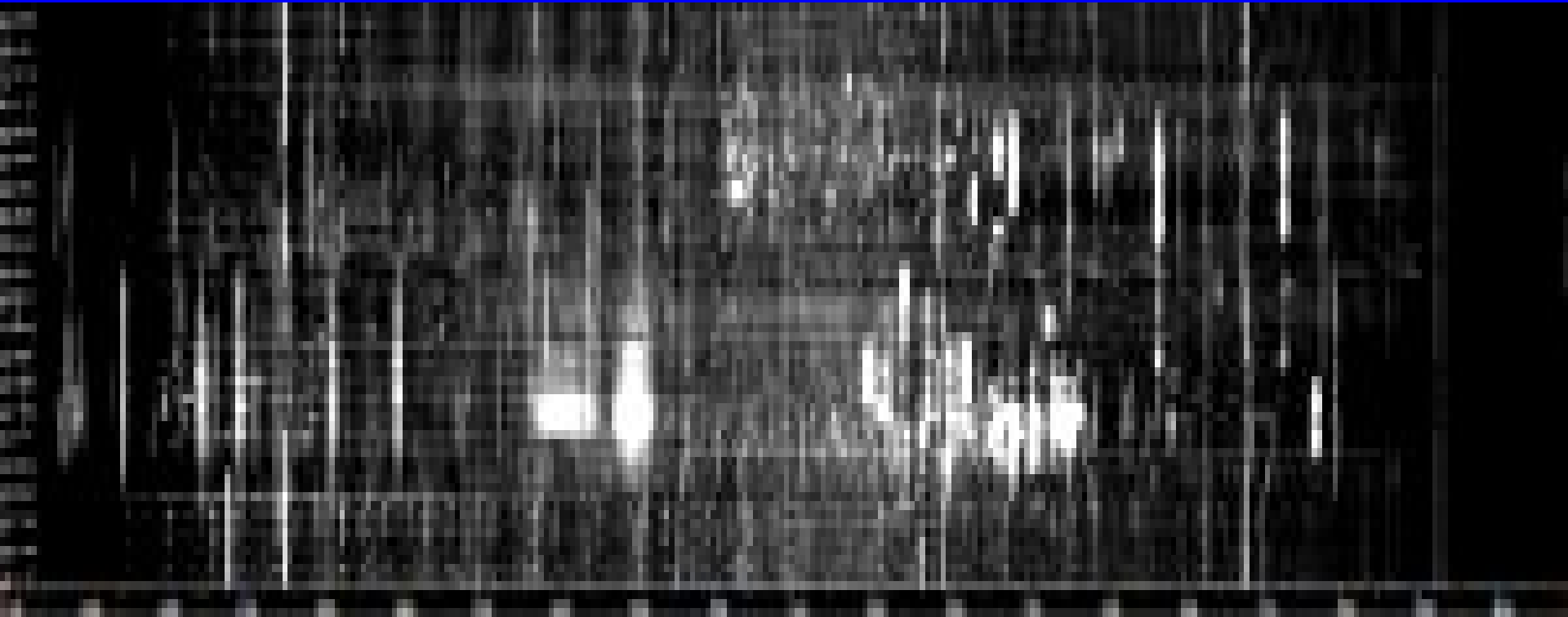

- Vertical lines may be switching power supplies or digital equipment turning on and off, some may be signals

24 Hours on 30M at NK7Z

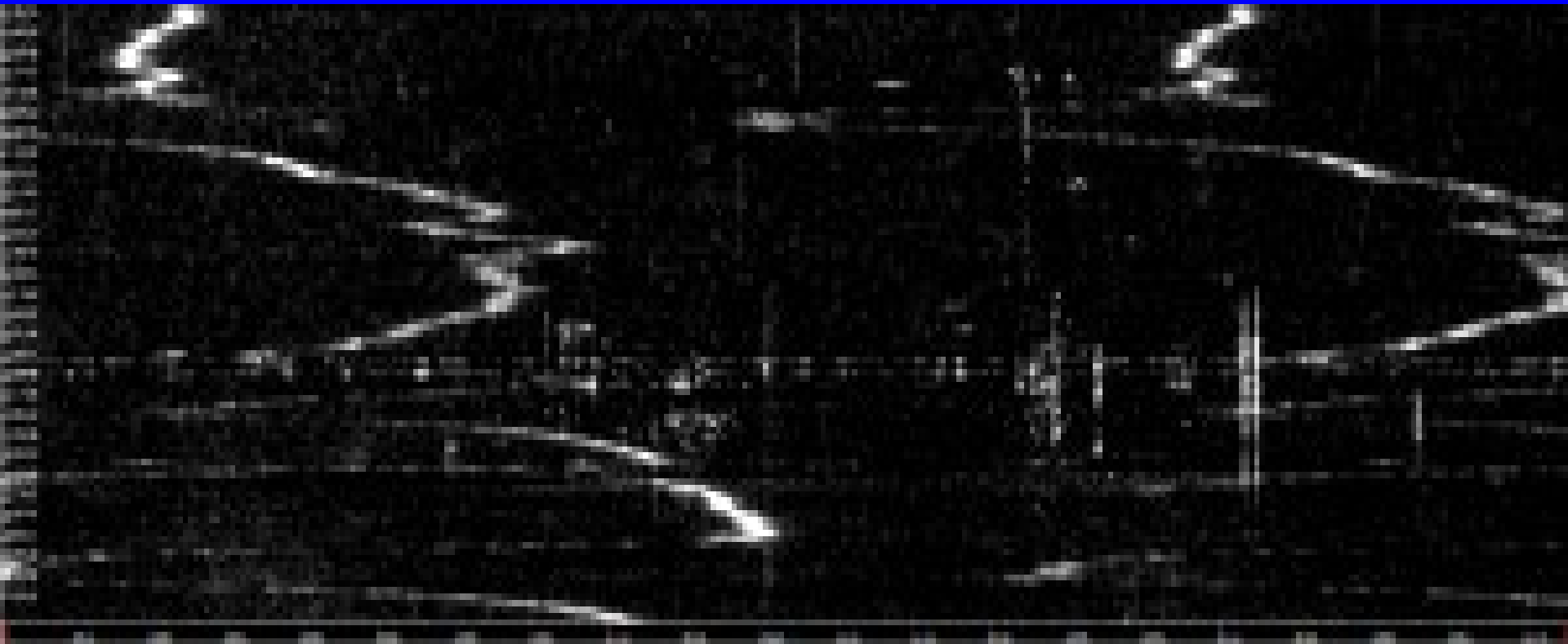

- **Drifting traces are typical of SMPS, grow lights, variable-speed motor controllers**

24 Hours on 30M at NK7Z

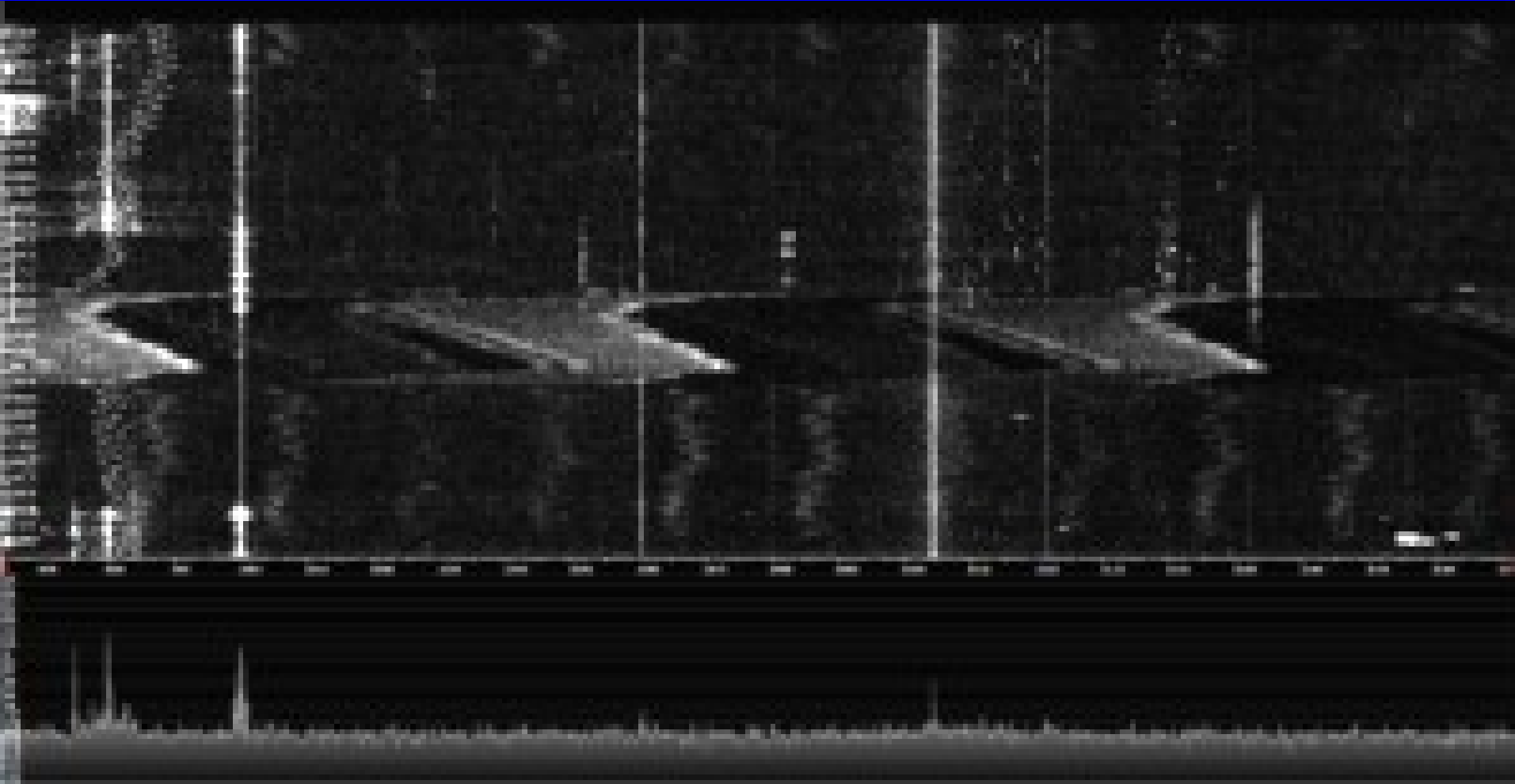

- **Grow lights cycling on and off?**

24 hours on 160M at NK7Z

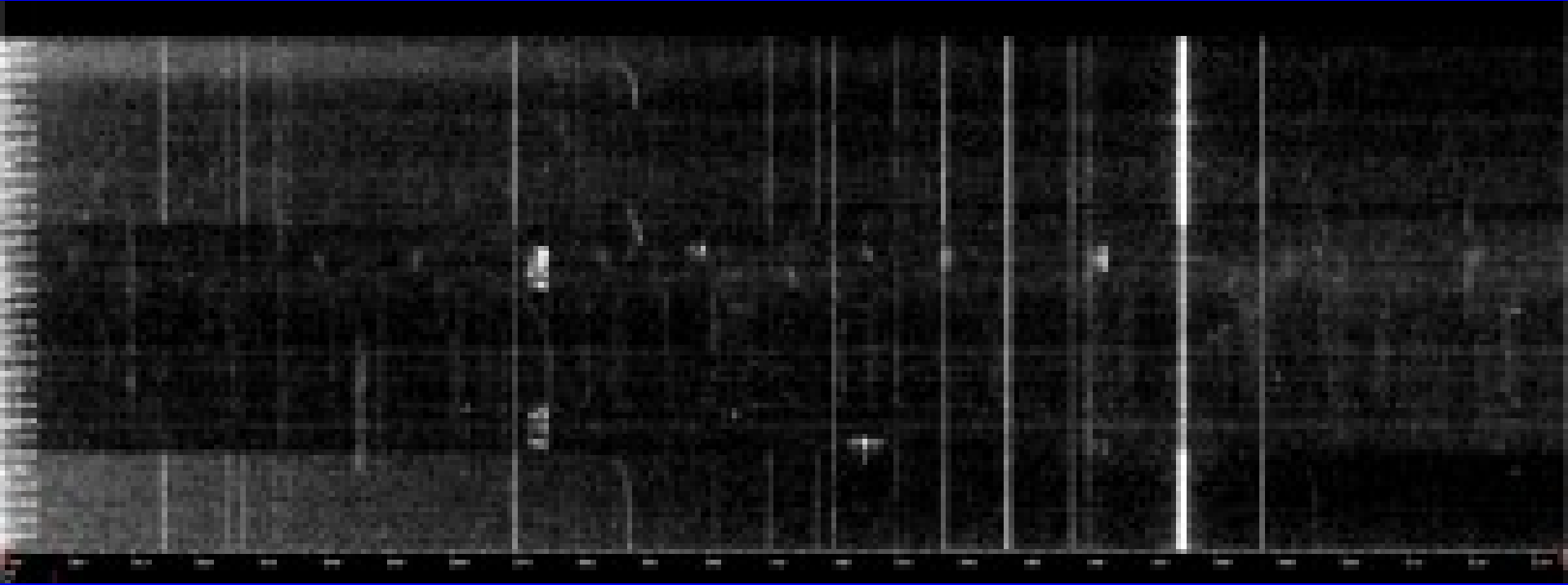

- **Vertical lines are switching power supplies or digital noise**

Portable Tracking Tools

- **Portable receiver**
 - **Tecsun PL660**
 - **Kenwood TH-F6A**
 - **Best for impulse noise sources**
- **Portable spectrum analyzer**
 - **Laptop or tablet with SDRPlay**
 - **Best for electronic noise sources**

Portable Tracking Tools



Tecsun PL660

**Kenwood
TH-F6A**

Finding Electronic Noise Sources

- **We must search for these sources at the frequencies where we hear them**
- **Receivers with spectrum displays are best**
 - **Noise from power supplies and variable-speed drive controllers often drifts, can drift away from where you're listening**
 - **Spectrum display can help identify what you're chasing**
 - **Before you start, make sure you're not chasing noise generated by your receiver (or vehicle)**

Identifying RF Noise Sources

- **Start with your own home first**
- **This usually gets rid of several strong noise sources**
- **Learn how to locate and kill noise at home, so you don't look like a dummy if you get the chance to work on your neighbor's noise**

Identifying RF Noise Sources

- **Run your station on a battery and kill power to your home**
- **Listen for noise on antennas nearest to your home**
- **If antenna switching depends on 120VAC power, you may need to patch around the switching**

Identifying RF Noise Sources

- **Turn off anything connected to a UPS, then turn off the UPS**
- **Any noise that goes away is your noise**
- **Restore power, turn off all breakers, then turn them back on one at a time while listening for noise in your shack**

Troubleshooting RFI

- **It usually helps to have an assistant**
- **One of you listens (or watches a spectrum display) while the other kills breakers one at a time (and then equipment connected to those circuits) to find noise sources**
- **One of you listens (or watches a spectrum display) while the other applies a fix**
- **Use VHF/UHF talkies to communicate**

Troubleshooting RFI

- RFI often comes from multiple sources
- **When you find one source, always assume that there may be others!**
- Take a methodical approach. Don't give up when one "right" technique doesn't fix it – keep on doing other "right" things. The "right" techniques really are right!

**How RF Noise Is Transmitted
and Received – Understanding
Common Mode
and Differential Mode
Transmission**

Differential Mode Transmission

- Current flow is in opposite directions on conductors in a signal circuit
- Voltage difference between conductors
- Signal is inside the coax
- Desired signal is always differential mode



Differential Mode Transmission

- Current flow is in opposite directions on conductors in a signal circuit
- Voltage difference between conductors
- Signal is inside the coax
- Noise can also be differential mode (inside the coax)



Killing Differential Mode RFI

- Filters only work on differential mode signals and noise
- Most RFI is not differential mode
- Most RFI is outside the coax



Common Mode Transmission

- **Current flows in same direction on all conductors (or on outside of coax shield)**
- **Voltage difference along conductors**
- **Signal (or noise) is outside the coax**
- **Cable acts as long wire antenna**



Common Mode Transmission

- **Current flow in same direction on all conductors (or outside of coax shield)**
- **Voltage difference along conductors**
- **Signal (or noise) is outside the coax**
- **Also couples power line hum and buzz**



Common Mode Transmission

- **Many antennas are unbalanced by their surroundings**
 - **Ground slope, unequal heights, surrounding conductive objects**
- **Two-wire “balanced” line carries common mode current when the system (antenna plus line plus tuner) is not well balanced**
- **Current in two conductors is not equal, the difference is common mode current**

Understanding Accidental Antennas

Basic Random Long Wire

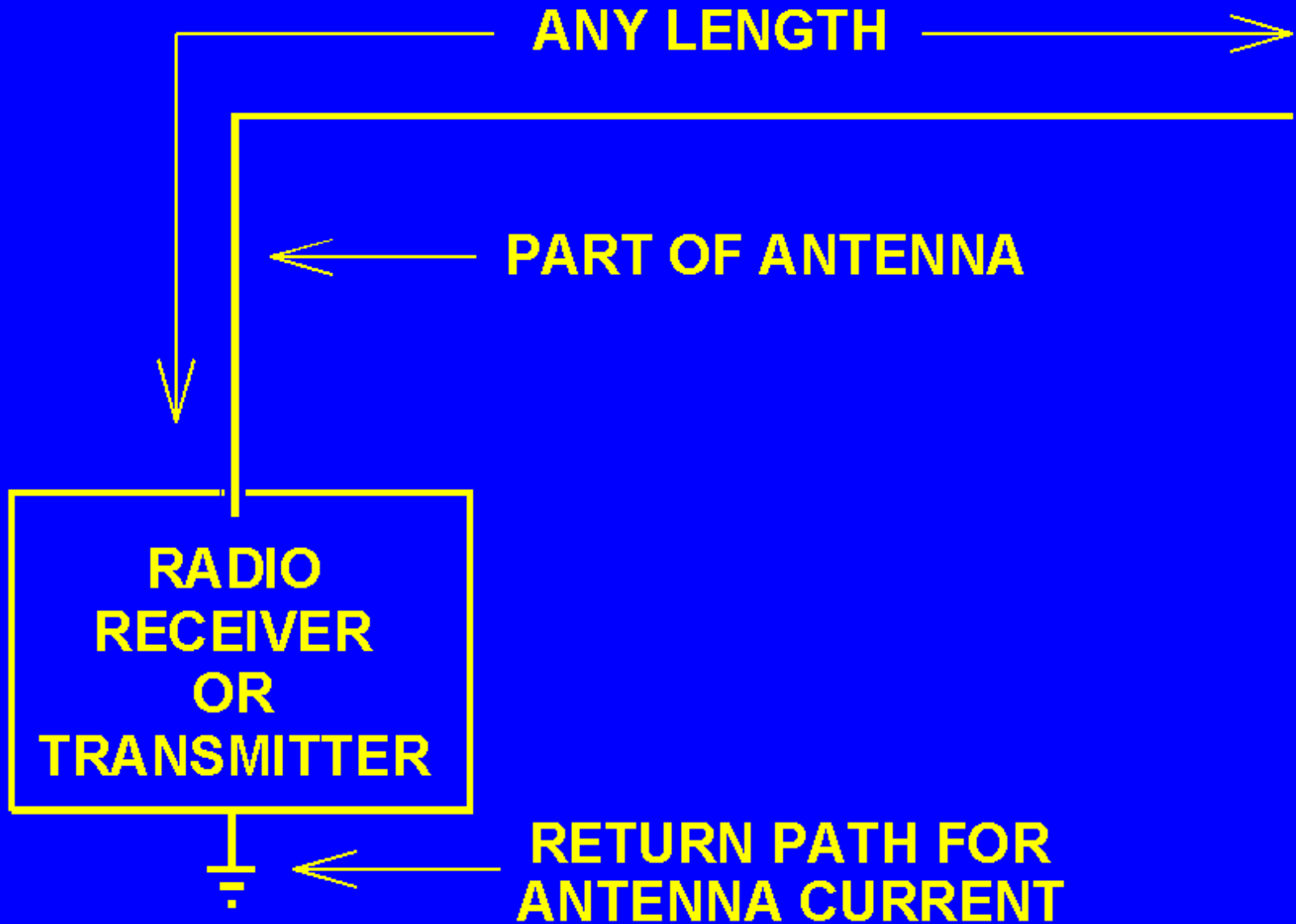

Basic Random Long Wire

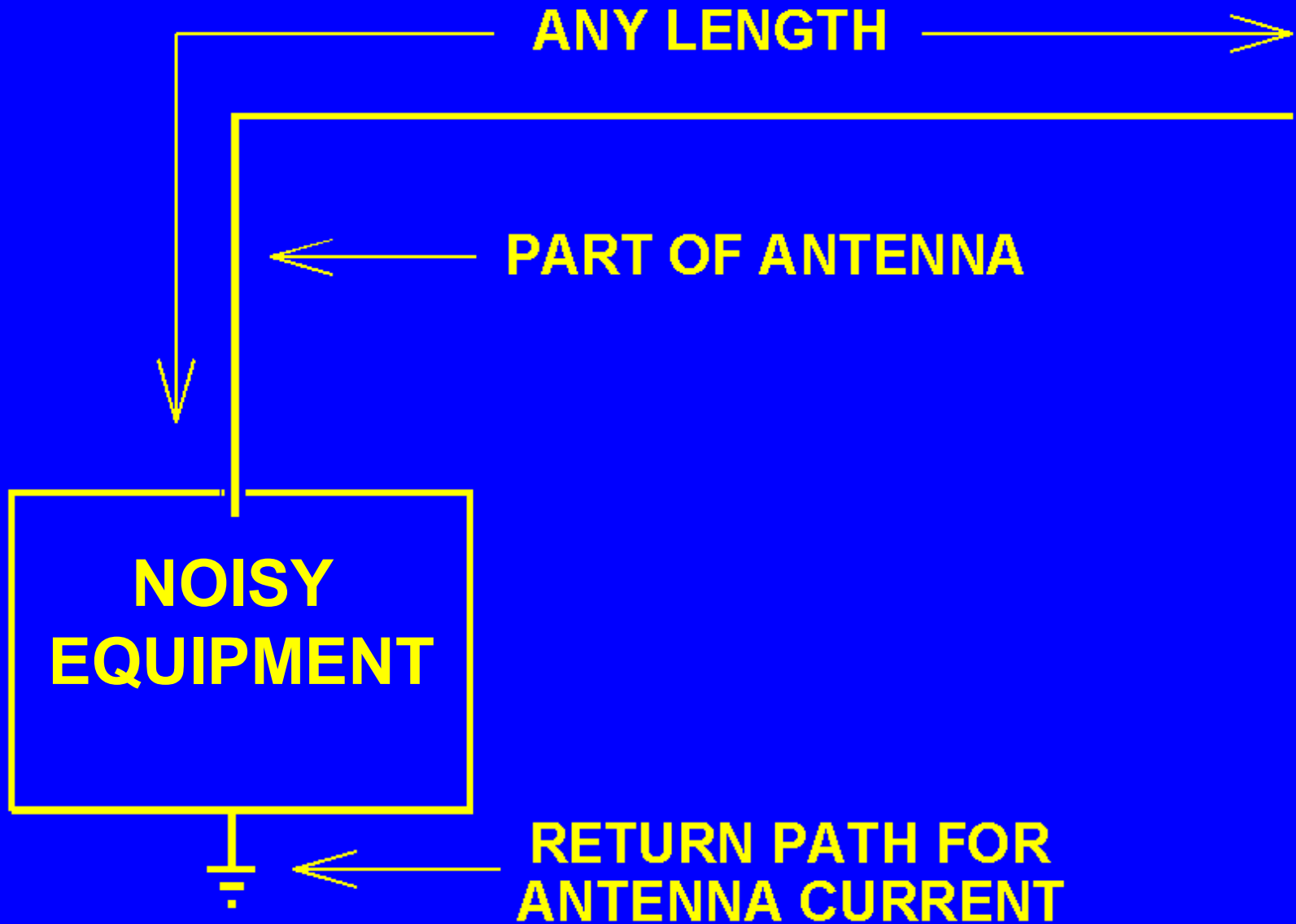

A “Textbook” $\lambda / 2$ Dipole

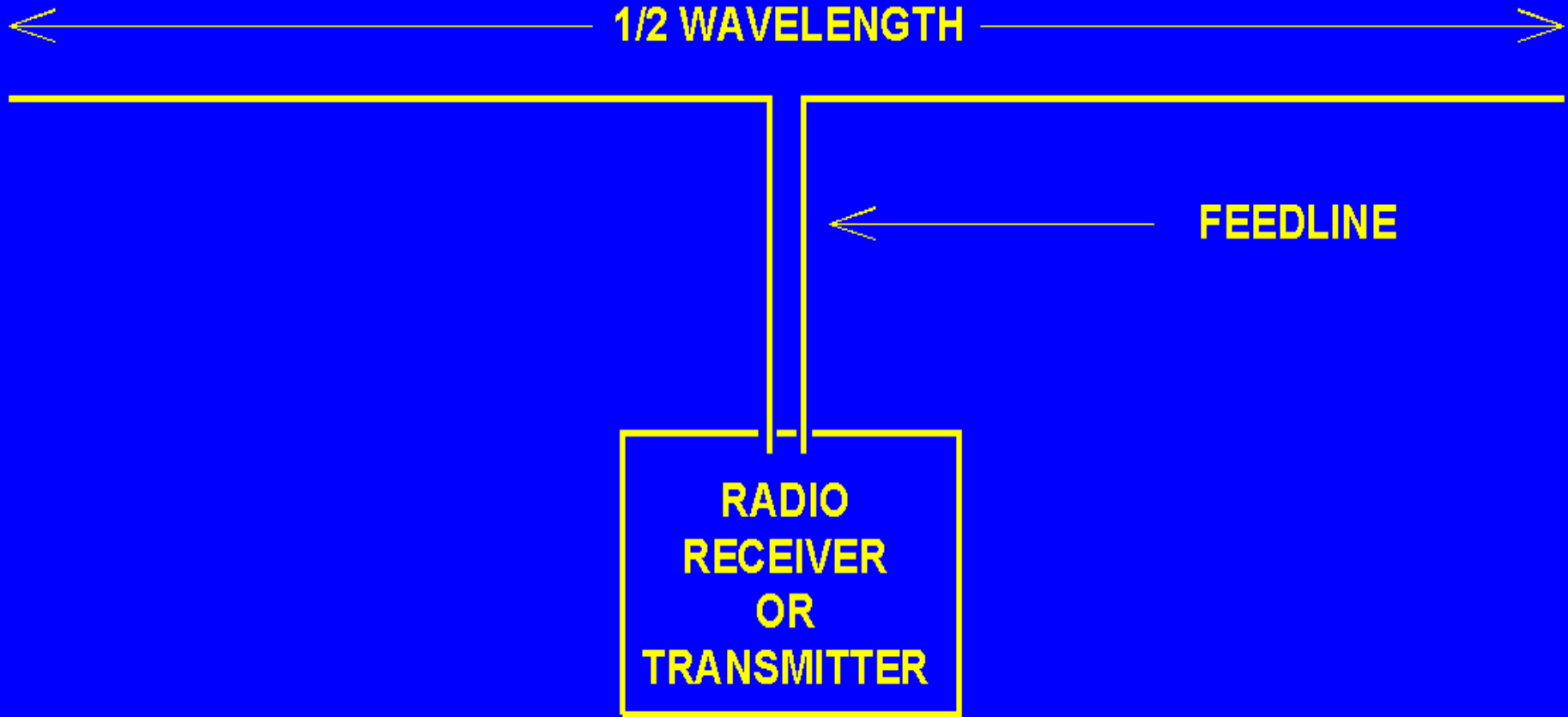

Equipment Can Be The Other Half of a Dipole

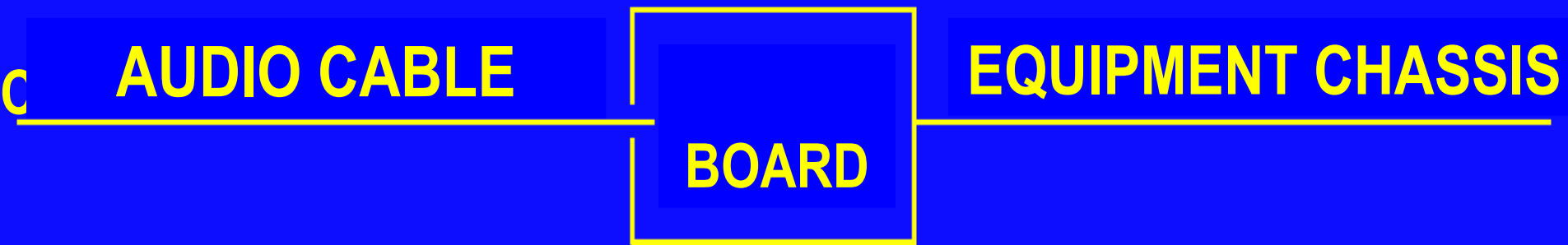

That's how a rubber duck works on a talkie – the chassis, plus our arm holding it, are part of the antenna!

Equipment Can Be The Other Half of a Dipole

AUDIO CABLE

**NOISY
EQUIP-
MENT**

EQUIPMENT CHASSIS

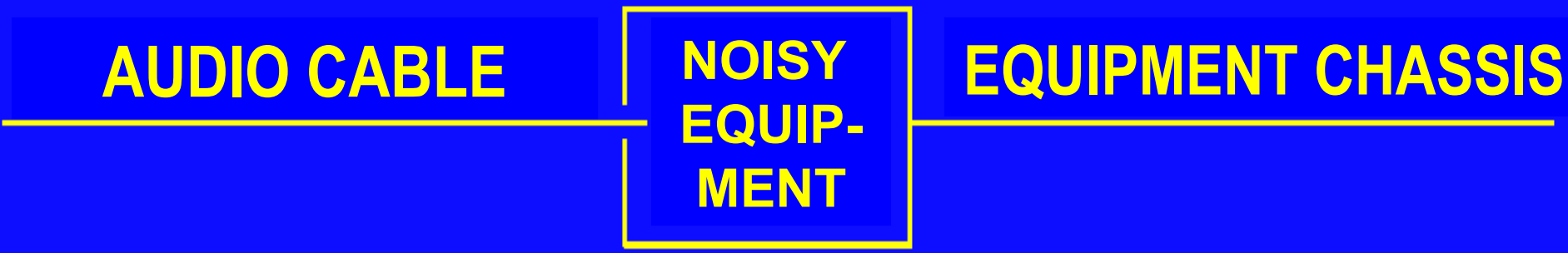

**Common Mode RF Current
on Any Cable Makes It An
Accidental Antenna!**

Chokes on Antennas Can Kill Noise

- Wires wound through ferrite cores are common mode chokes, and block common mode current**
- Common mode noise current is picked up on antenna feedlines**
- Ferrite chokes prevent it from coupling to the antenna, and from there to our rig**

Chokes on Antennas to Kill Noise

- Specific designs are in Chapter 7
(Choke Cookbook)
k9yc.com/RFI-Ham.pdf
- Also study
<http://k9yc.com/CoaxChokesPPT.pdf>
to understand why it matters
- We'll talk more about chokes later on

The Principle of Reciprocity – Coupling Works Both Ways

- Techniques that minimize received interference will generally also reduce radiated noise
- Relative strength of coupling depends on impedances of the coupled circuits, and may not be equal in both directions

The Principle of Reciprocity – Coupling Works Both Ways

- **Mistakes that let RFI into the box also let it out of the box**
 - **Pin One Problems**
 - **Poor Shielding**
 - **Poor Filtering**
 - **Large magnetic loop area**
 - **Accidental Antennas**

Magnetic Coupling

- **Often overlooked by circuit and system designers**
- **A very potent coupling mechanism**
- **Strongly couples any large currents**
 - **Solar systems**
 - **Battery chargers**
 - **Variable speed motor controllers**
 - **Lighting systems**

Current Flows in Loops

- **Where does the return current flow?**
 - Large loop area = strong magnetic field
 - Large loop area = greater coupling
 - Long wires = better antennas
- **Good RFI design = very small loop areas and short antennas (or no antennas)**
 - Put RF bypass cap directly between C and E of switching transistor, zero length leads
 - Keeps the loop area small for RF current

Keeping Loop Area Small

- **Use multi-layer circuit boards**
- **Add a reference plane on a second layer**
 - **Current returns on layer under trace**
 - **Each circuit trace is now a transmission line**
 - **Minimizes the loop area**
 - **Minimizes antenna action**
 - **Microstrip (one reference plane)**
 - **Stripline (two reference planes sandwich the trace)**

Circuit Layout

- Always ask, “*Where does the return current flow?*”
- **Path at RF may be very different from the path at DC and low audio frequencies**
- Henry Ott talks about “the hidden schematic lurking behind the ground symbols”
- **Large loops cause magnetic coupling and/or antenna action**

System Wiring To Minimize RFI

- **Make every path between equipment a transmission line**
 - **Use coax or twisted pair**
- **Makes the loop area very small**
- **Use twisted pair for circuits carrying AC or DC power**

Common Mode Coupling

- So How does RF get into (and out of) the box?



Common Mode Coupling

- So How does RF get into the box?

Pin One Problems!



Common Mode Coupling

- So How does RF get out of the box?

Pin One Problems!



What's A Pin One Problem?

- The cable shield fails to go directly to the shielding enclosure
- The cable shield goes through a hole in the shielding enclosure to interior wiring (usually a circuit board)

What's A "Pin One Problem?"

- Named "the Pin One Problem" because the cable shield is on Pin One of XL-connectors used in pro audio to carry balanced mic and line signals**
- Identified by Neil Muncy, ex-W3WJE (SK), an excellent EE working in pro audio**

Pin 1 Problem in Balanced Interfaces

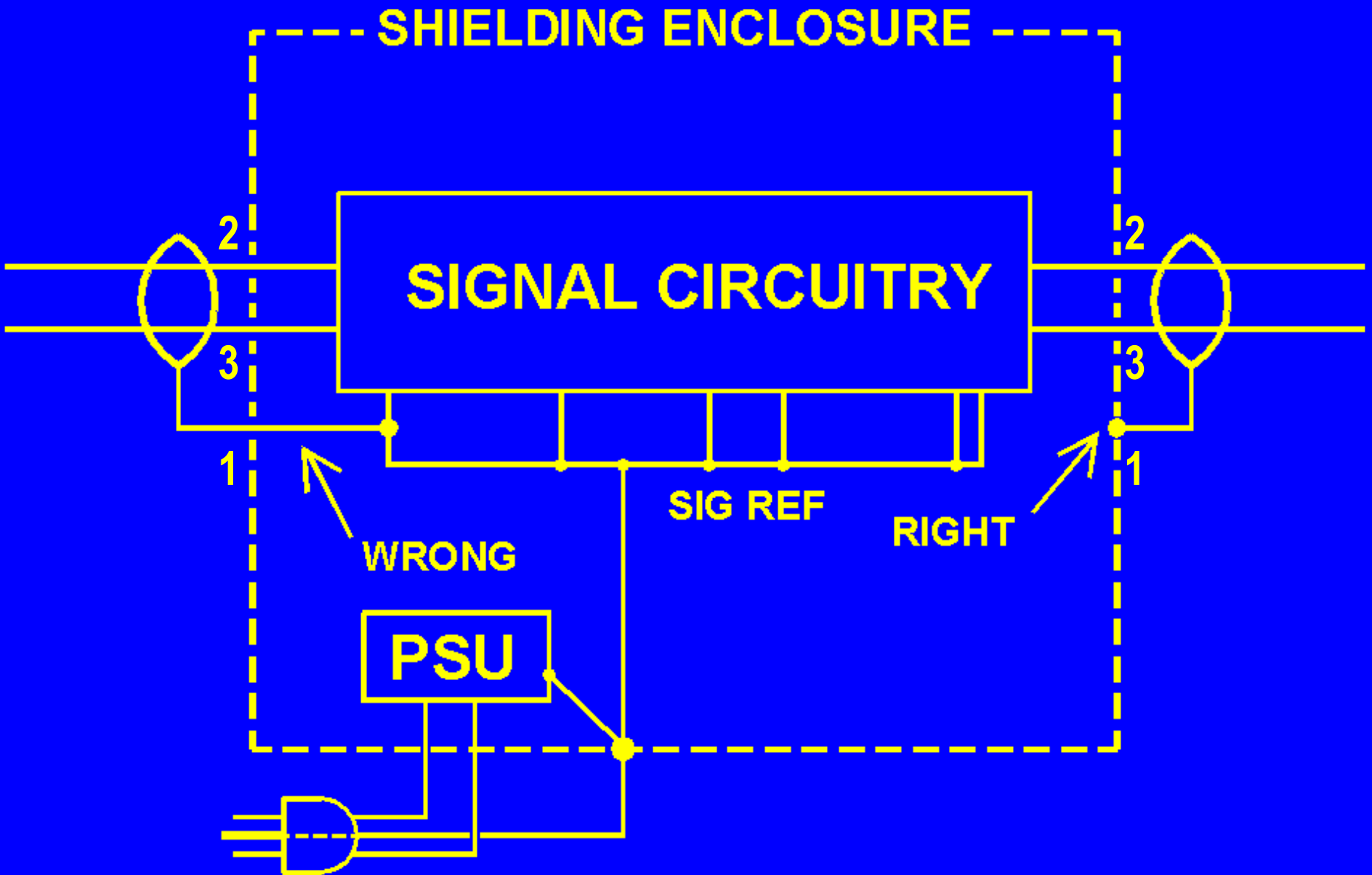

Pin 1 Problem in Balanced Interfaces

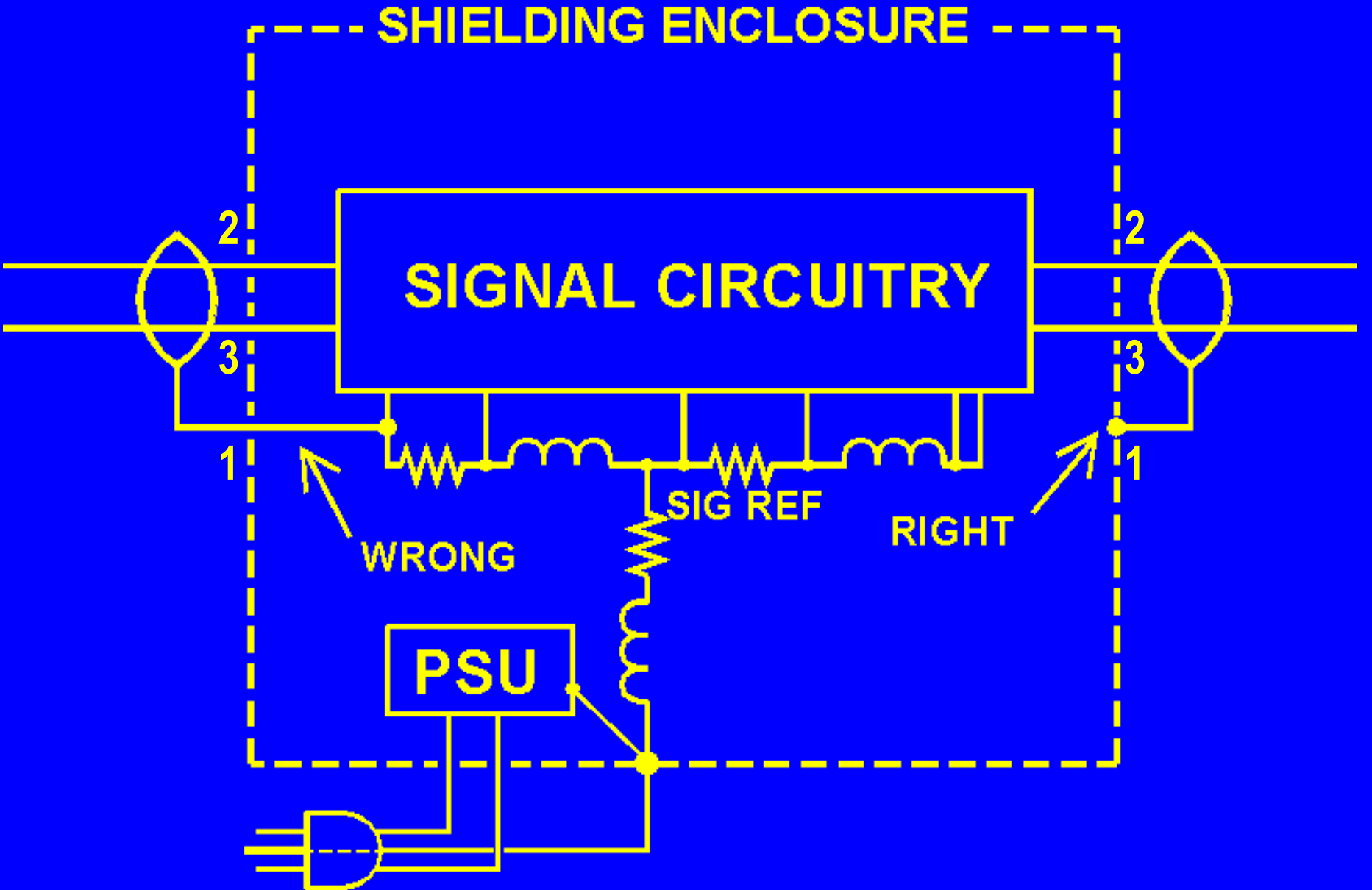

Pin One In Unbalanced Interfaces

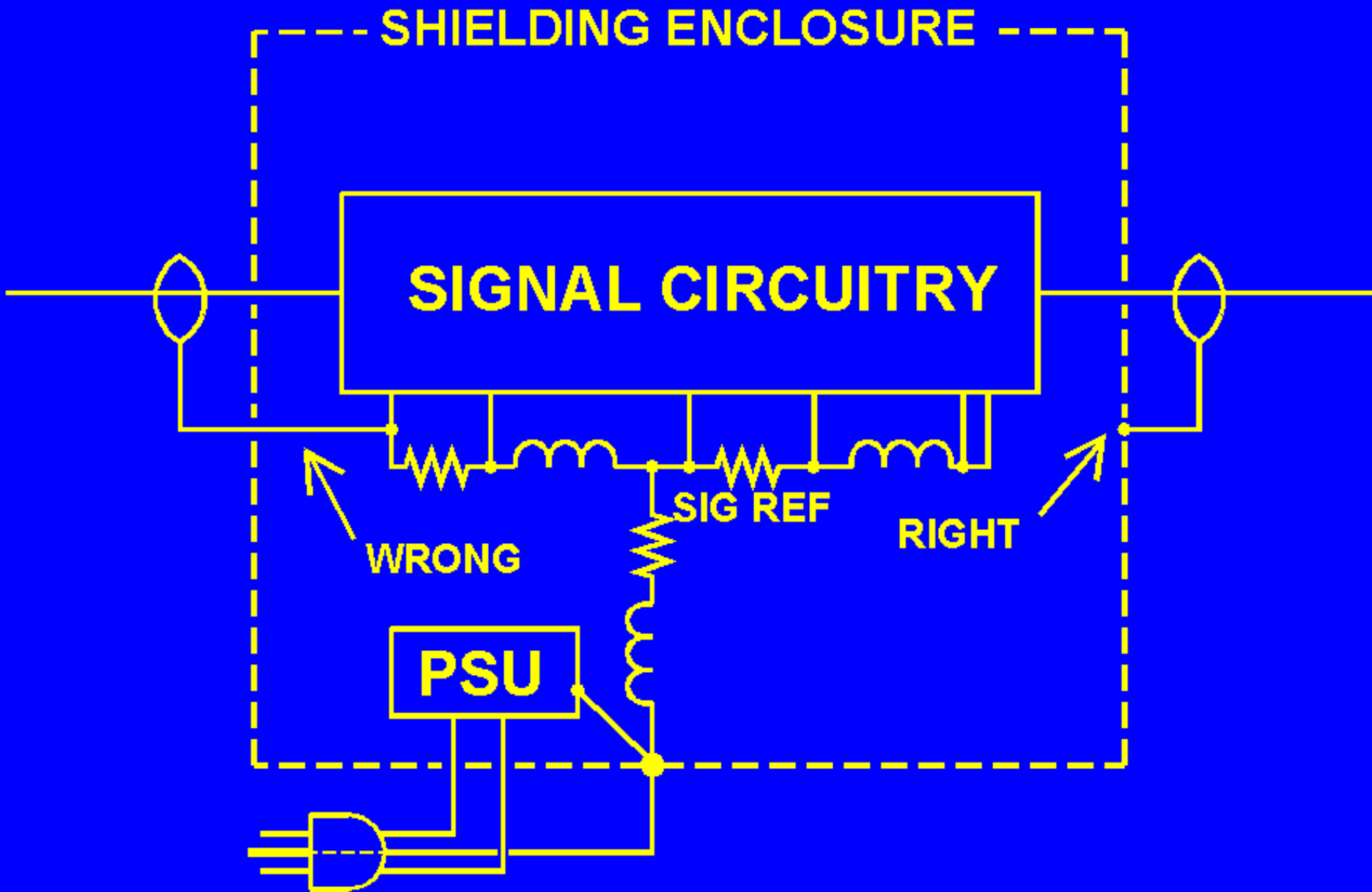

“Green Wire” “Pin One-Like” Problem

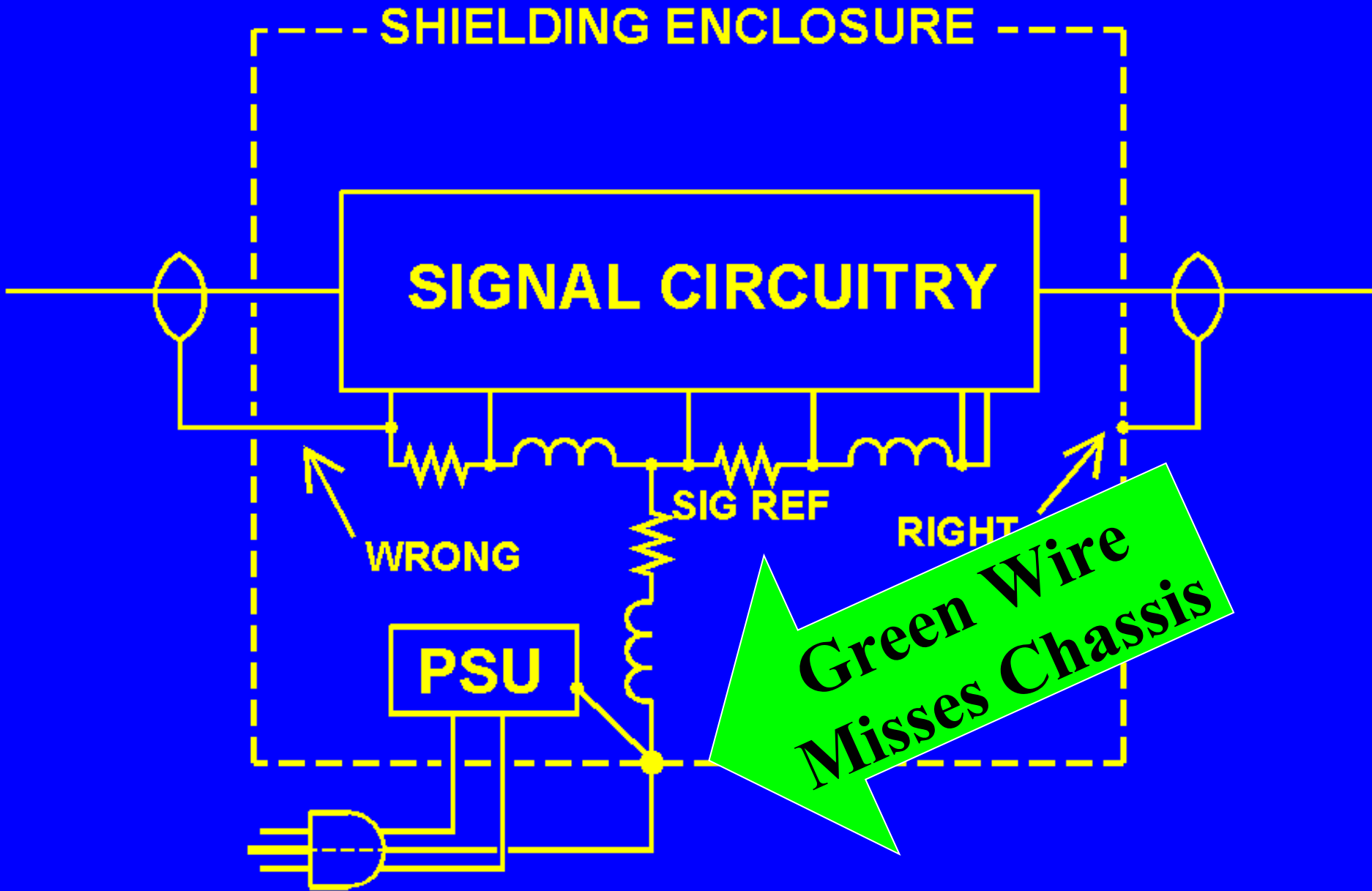

**Most RFI is caused by
Pin 1 Problems!**

**That Includes “RF in
the Shack,” or “RF
Feedback!”**

Nearly All Equipment Is Built With Pin 1 Problems

- **Audio and Video Gear**
 - **Home and Professional Audio Systems**
 - **TV Sets, Video Recorders, Cable Boxes**
- **Computers and Accessories**
- **Ham Rigs and Accessories**
- **Telephone Equipment**

How Do Pin Problems Happen?



Insulating rings around all connectors prevents chassis contact!



Nice Radio, Has Pin 1 Problems



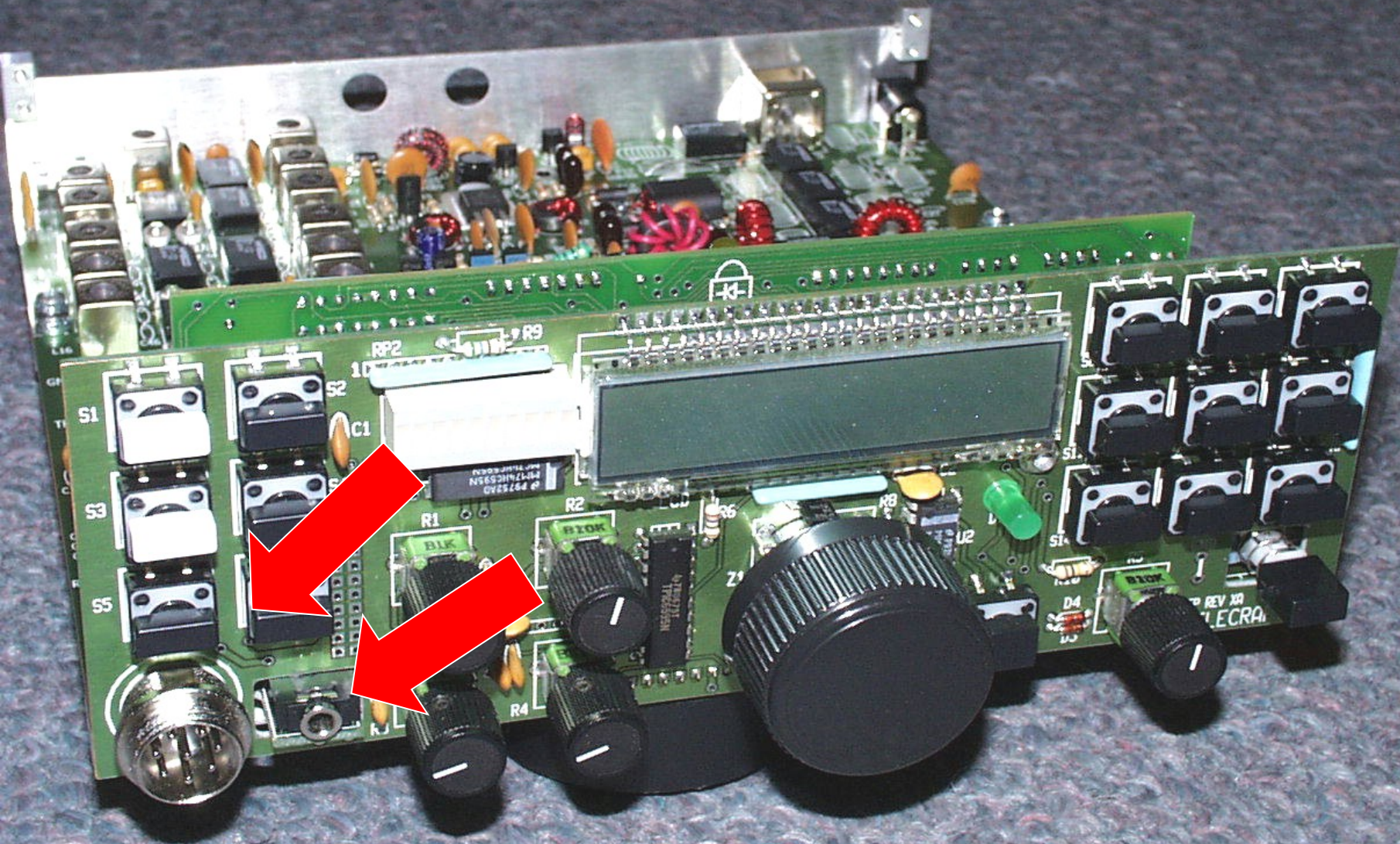

RCA Jacks
Float

Ten Tec Omni V



Potter & Brumfield
T90 SERIES

81333
PASSBAND
TUNING
BOARD

92186
1B

81456

66

64

39

41

216

SM

NS

9040

480

BRD

50

57

66

5

38

A Pin 1 Problem in FT-1000MP



RF Feedback on 75 and 15 Meters

Multiple Pin 1 problems cause hum, buzz, and probably RF feedback

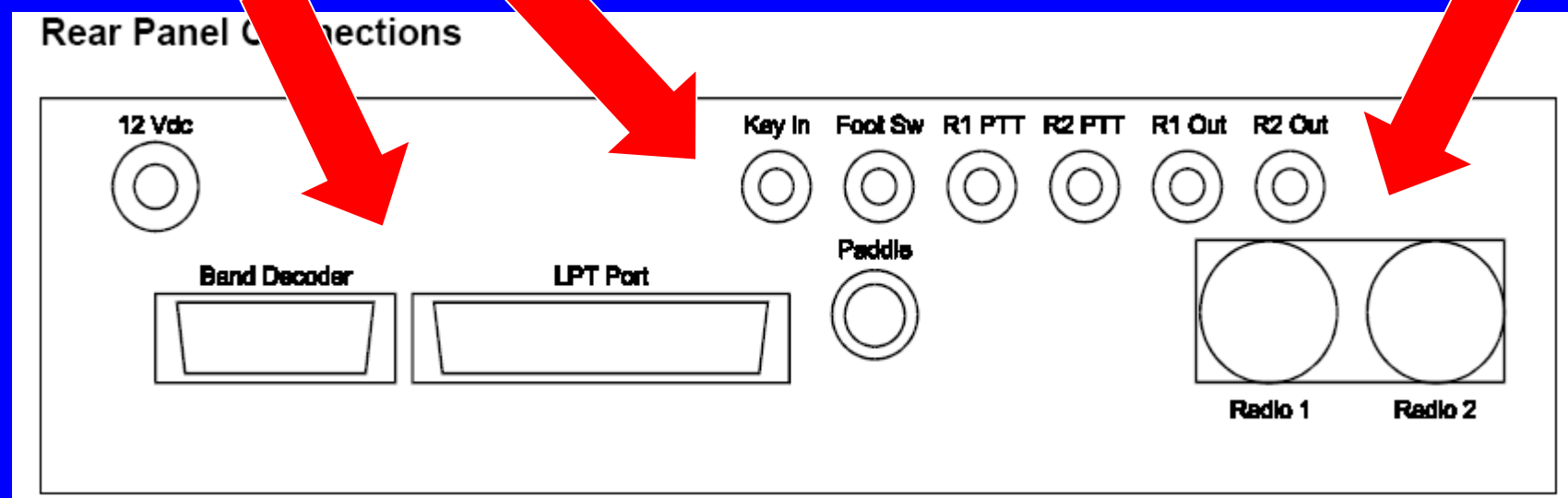

Where are the Chassis Connections for this laptop's sound card?

- Hint: It isn't an audio connector shell!
 - They should be, but they are not!

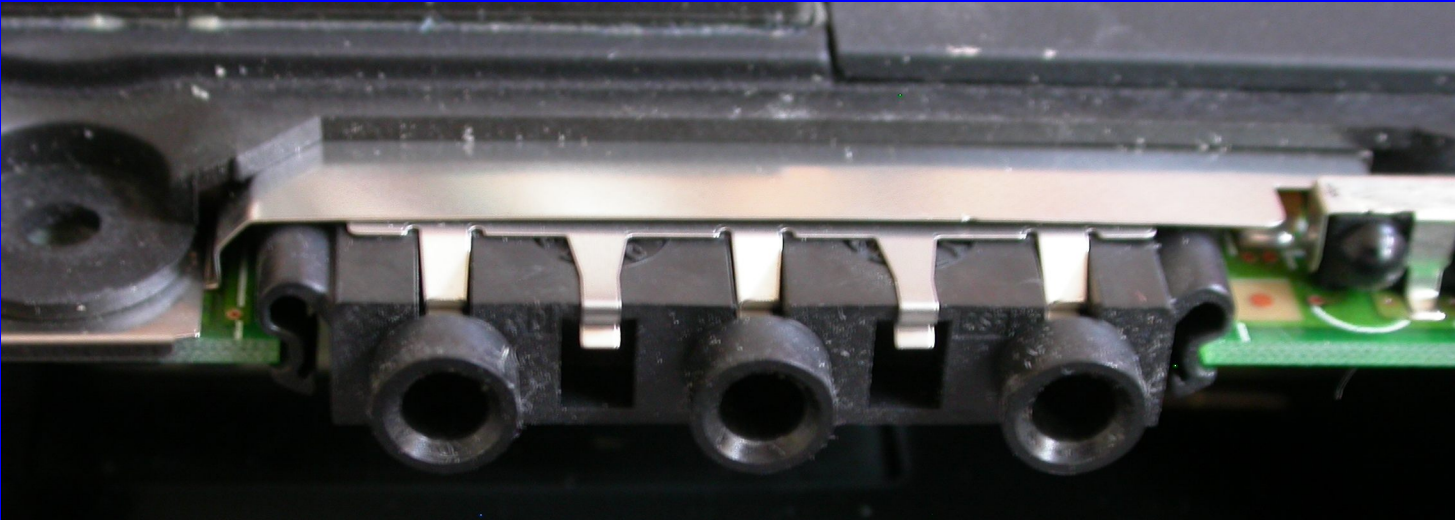

**Where are the Chassis Connections
for this laptop's sound card?**

Yes, it's the DB9, DB15, and DB25 shells!



How Does It Happen?

- **Connectors are mounted to PC board**
- **Shell not bonded to chassis**
 - **It should be, but it isn't – that costs more!**
- **Often very difficult to fix**
- **All inputs and outputs are usually bad**
 - **Audio and video**
 - **Serial and USB interfaces**
 - **Control wiring**

Green Wire “Pin One-Like” Problems

- **Astron Power Supplies**
 - **Green Wire to Terminal Strip insulated from chassis by paint**

A Green Wire Pin One Problem



A Green Wire Pin One Problem

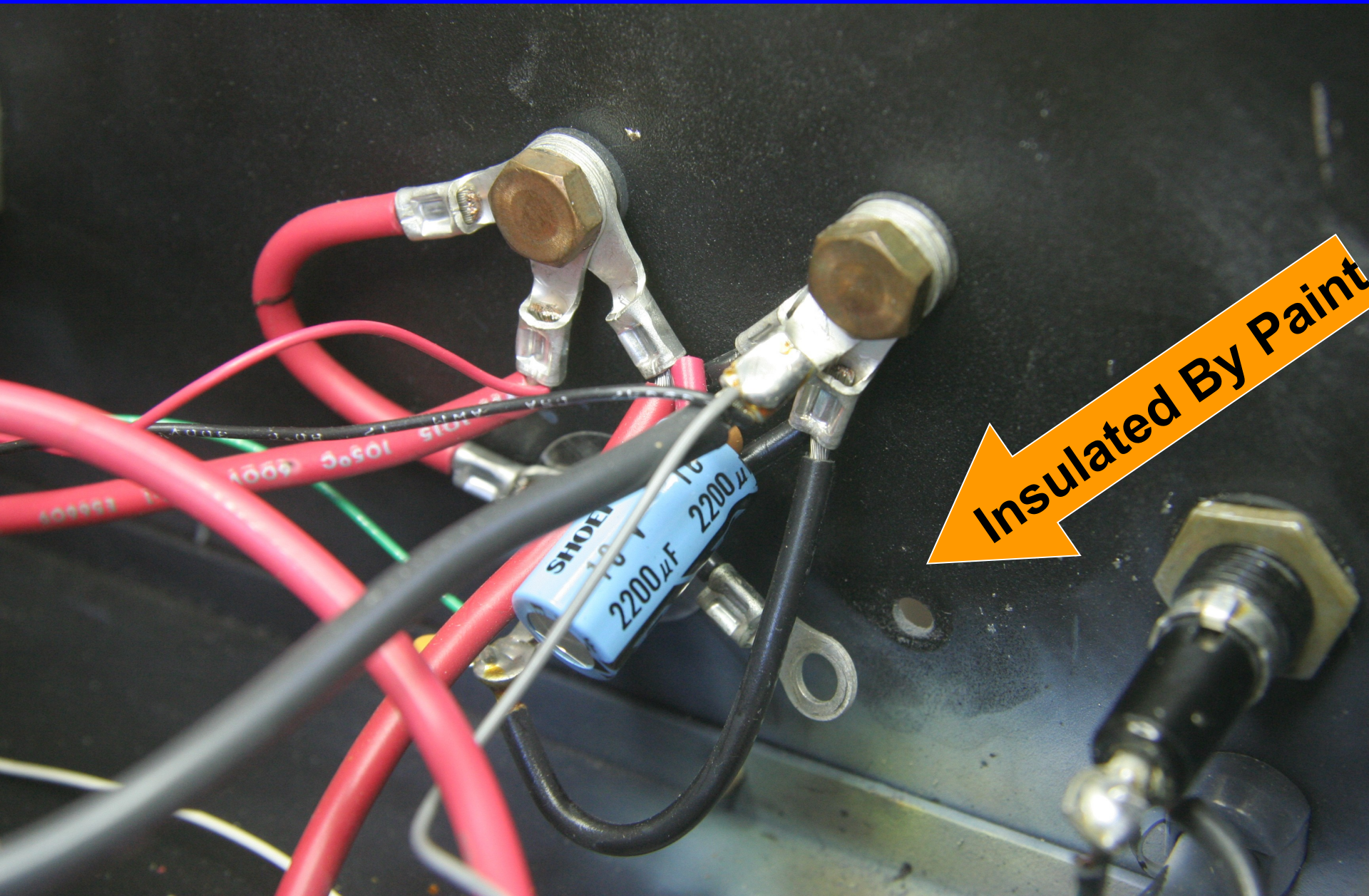

Insulated By Paint

Pin One Problems Go Both Ways

- Any RF on the return bus goes out on the cable shield (or the green wire)
- RF current flows on the cable shield (or the green wire)
- The cable shield (or the green wire) becomes an antenna, radiating the noise
- Our antennas receive the noise

Killing Electronic Noise

Killing the Noise

- **Noise must be killed at the source**
- **We must find the source to kill the noise**
- **Exceptions**
 - **Directional antennas**
 - **Noise cancellation**
- **Noise cancellation only works on one source at a time**

Strategy to Kill RFI

- **How bad is the problem?**
- **Where is it leaking out?**
- **Work on most common problems first**
 - **Pin 1 Problems**
 - **Digital equipment**
- **Replace switching power supplies with linear supplies**
- **These problems have easy solutions**

Two Ways to Kill Pin One RFI

- **Rewire/rebuild the connector**
 - **Wire shield to the chassis, not PC board**
 - **Bond connector to chassis, not PC board**

Or:

- **Kill the current**
 - **Make the wiring a lousy antenna**
 - **Add a common mode choke**
 - **Short out the current**
 - **Kill the voltage that causes current flow**

Always Stay Outside the Box

- **Going inside is a bad idea**
 - **Voids warranties**
 - **Your neighbor will never let you**
 - **Opens up a can of worms with possible instability (oscillation, functions don't work, etc.)**
- **Never modify equipment unless you're prepared to close that can of worms!**

The Best Ways to Kill Pin One RFI

- **Kill the current**
 - **Make the wiring a lousy antenna**
 - **Add a common mode choke**
 - **Short out the current**
 - **Kill the voltage that causes current flow**

RFI From Electronic Sources

- **What are the antennas?**
 - **Every interconnecting cable**
 - **The AC power line**
- **Wind enough turns of AC cable through toroid to form choke**
- **Do the same with every cable connected to the noise source**

RFI From TV Sets, Cable Boxes

- **What are the antennas?**
 - **Every audio/video cable**
 - **Coax from antenna, cable box, DVR**
 - **The AC power line**
- **Wind multiple turns of AC cable through toroid to form choke**
- **Wind every cable through a toroid to form choke**

Good Solutions

- **Use ferrite common mode chokes**
- **Bond equipment chassis-to-chassis when possible**
- **Replace noisy equipment with equipment that isn't noisy**

RFI From Switching Power Supplies

- **What are the antennas?**
 - **The DC cable**
 - **The AC power line**

Switching Power Supplies

- **Replace the noisy supply if possible**
- **If you can't (if it's built into equipment)**
 - **Wind each cable through a ferrite core to form a choke**
 - **Plug supplies into multi-outlet boxes and wind AC power cable through toroids to form chokes**

Linear Supply (Top) and SMPS (Lower), both 12V @ 750 mA



Plug Noisy Power Supplies Into Choked Power Outlets

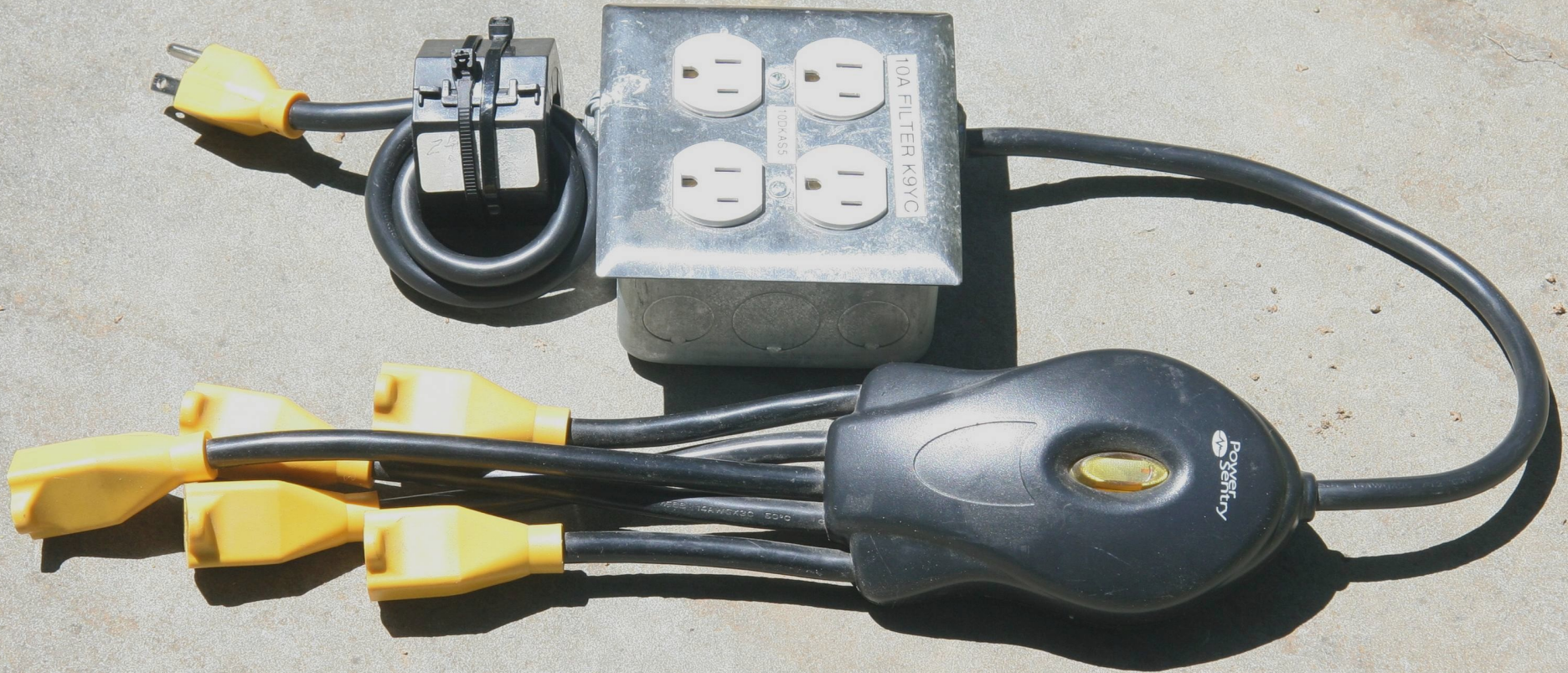

Identifying Noisy Power Supplies

- **Use an AM radio with an internal loopstick antenna**
 - **TH-F6A, or any portable AM radio**
- **Tune between stations 1.5 – 2 MHz**
- **Place loopstick next to the power supply (with the power supply running)**
- **If you hear hash, it's a switch-mode power supply, and should be replaced**

Replace Noisy Power Supplies

- **Great solution for outboard DC supplies**
 - Wall warts, line lumps
 - Battery chargers
- **Not practical for switching power supplies built into equipment**
 - Going inside the box is a bad idea

Replacing Switching Power Supplies

- **Keep old linear wall warts and line lumps for equipment you no longer use, collect them in your parts stash**
- **Find more at ham flea markets and at second hand stores (\$ 1 typical cost)**
- **Some switching power supplies from better laptop mfrs are pretty quiet, and are usually regulated supplies**

Replacing Switching Power Supplies

- **Match voltage and current ratings of linear unit with the one to be replaced**
- **Cut both DC cables**
- **Put Power Pole connectors on cables from the linear wall wart and the power connector for the equipment**

Measuring Voltage and Current

- Linear supplies have capacitor filter, but are usually unregulated, so DC voltage will be higher than rated with no load
- Power Poles make it easy to patch in a volt/ammeter to verify that voltage is OK with equipment operating



Don't Trust the Current Reading

- **Most inexpensive ammeters measure current in the negative lead**
- **The current reading is often wrong if multiple pieces of equipment running from the same DC supply are interconnected by shielded cables or are bonded together**



This Unit Measures Correctly

- Measures current in the positive lead
- About \$80 from DC Power, in exhibit area



Same price at **DX Engineering**

**Killing Noise From
Equipment You Cannot
Replace**

Which Cables Carry Noise Current?

- Use an RF current probe

RF Current Probe

- **MFJ-805 (\$100)**
- **Or build your own**
 - Cheap if you have a good junk box
 - w8ji.com/building_a_current_meter.htm
 - ifwtech.co.uk/g3sek/clamp-on/clamp-on.htm
- **Portable radio using a loopstick antenna is much more sensitive**
 - **Tecsun PL660**
 - **Kenwood TH-F6A**

RF Current Probes



**Kenwood
TH-F6A**

MFJ-805

**Use Ferrite Common Mode
Chokes to Kill the Current**

Ferrites can block RF current!



Different sizes and shapes

2.4" o.d.

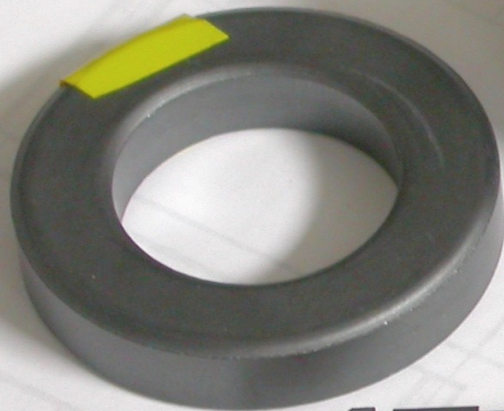

1" i.d.

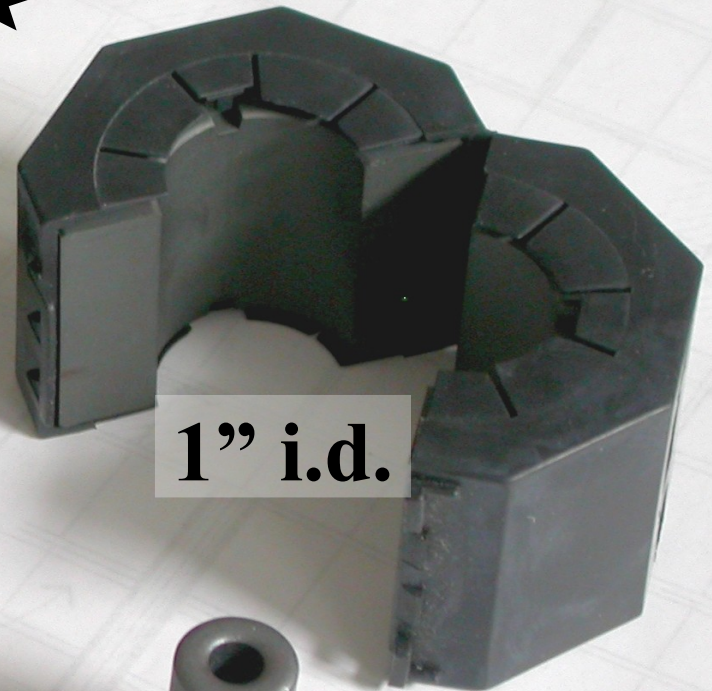

1" i.d.

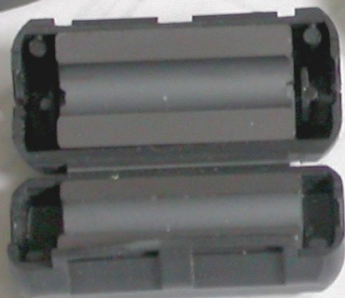

0.25" i.d.



They can look alike, but be very different



They're brittle!



What Common Mode Chokes Do

- Add high resistive impedance in series with the common mode circuit, reducing antenna current
- Have no effect on differential signals carried between the conductors, inside the cable

How Ferrite Chokes Work

- Choke is a parallel resonant circuit
- A parallel resonant circuit acts like big resistor at resonance
- We use that resistance to kill common mode current
- A single turn (wire goes through core once) is resonant around 150 MHz
- A single turn is useless on HF bands
- Multiple turns are required to move resonance down to HF

Why Resonance Moves Down

- **The choke behaves just like any other coil, where N is the number of turns**
 - **Except that all of the flux is in the core**
- **Inductance increases as N^2**
- **Capacitance increases as N**
- **Resistance increases as N^2**
- **We want the resonance where we need suppression**

#43 mix toroid, 1 – 5 turns

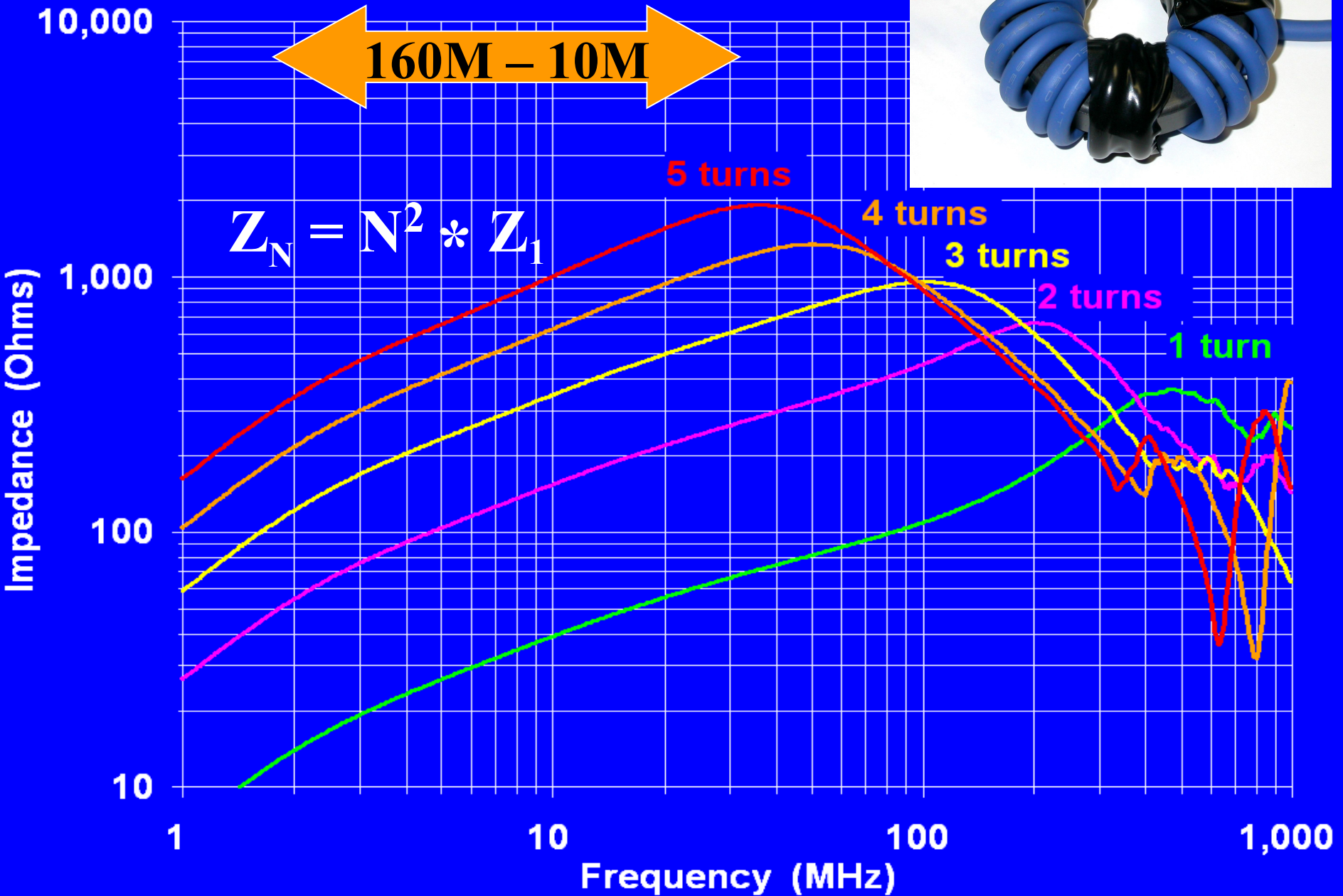

#43 mix – Good

160M – 10M

above 5 MHz

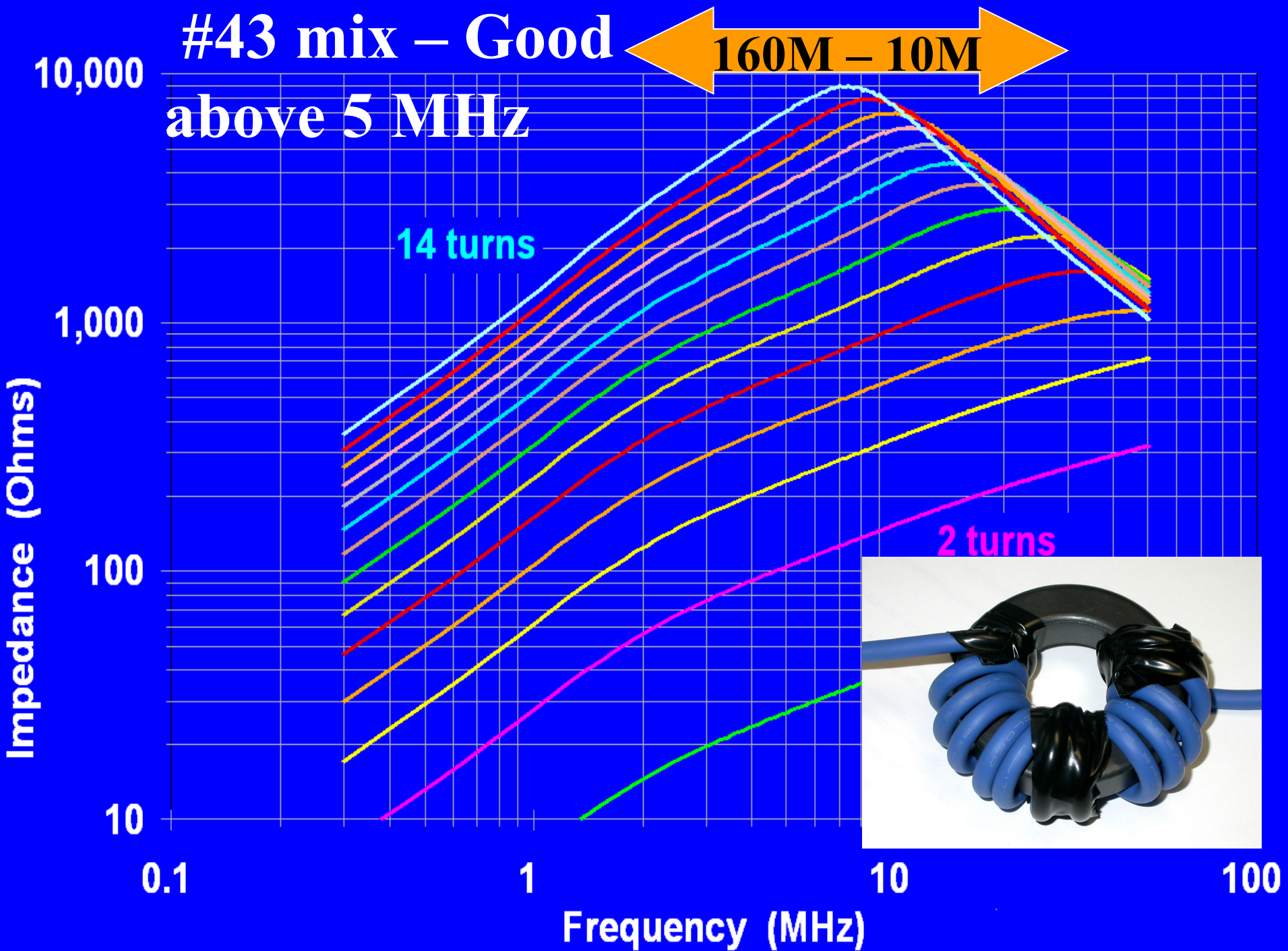

#31 Mix is best for HF bands

160M – 10M

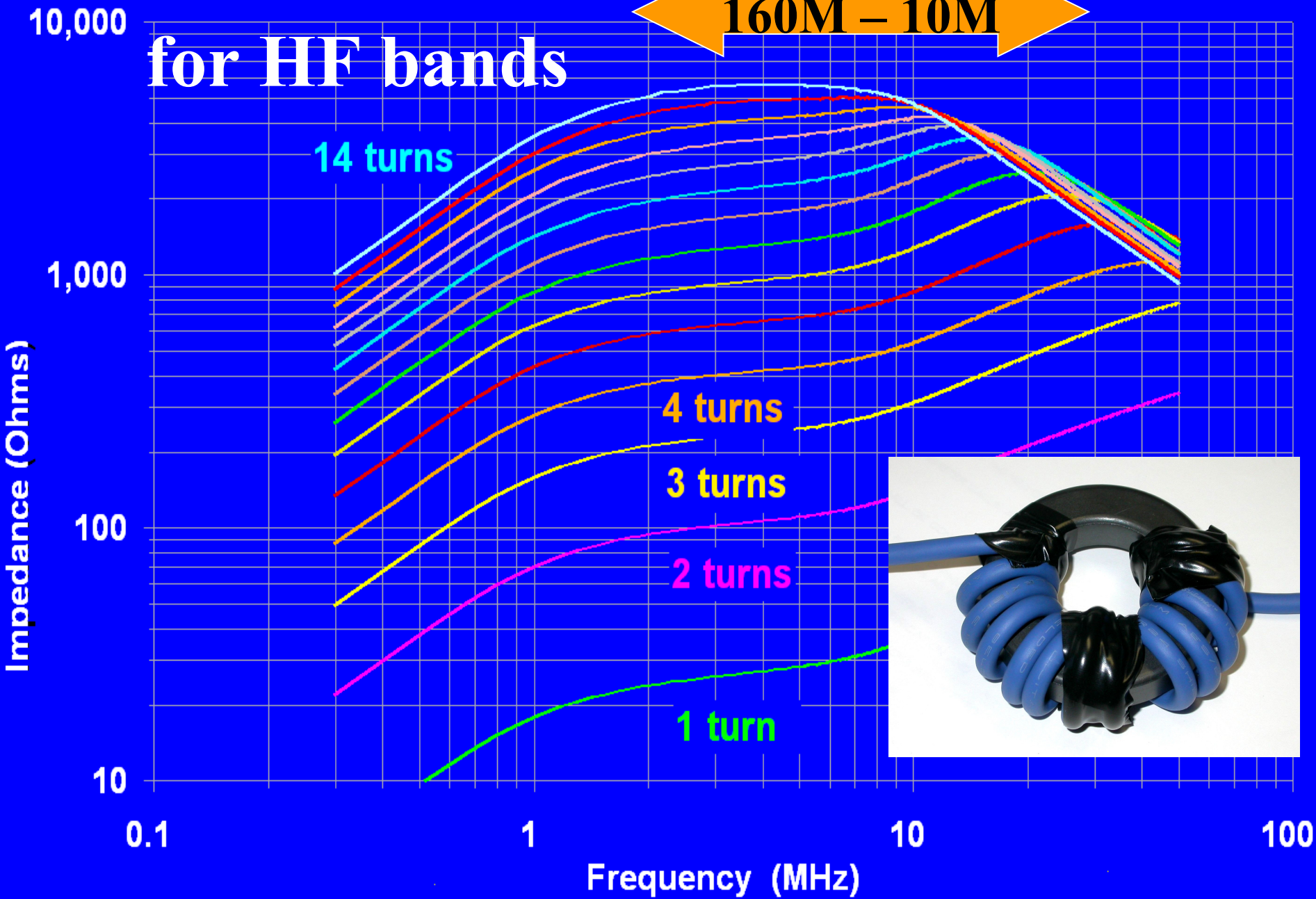

Resonance in Ferrite Chokes

- Ferrite materials are useful for suppression when they are very lossy
- That is, R is nearly the same as X_L or larger
- This gives the resonance very low Q
- Low Q means very broad
- An effective choke has a Q around 0.5

Resonance in Ferrite Chokes

- **Because Q is so low, resonance is very broad**
 - **Tuning is not critical**
 - **Choke on #31 material can cover three harmonically related ham bands**
- **To move resonance down**
 - **More turns => more L**
 - **Squeeze turns together => more C**

T

**effective from 80-300 MHz, but
more than one core may be needed**



**This 4-turn choke (#31, #43) is
about right for 15-30 MHz**



**This 5-turn choke (#31, #43) is
about right for 7-30 MHz**

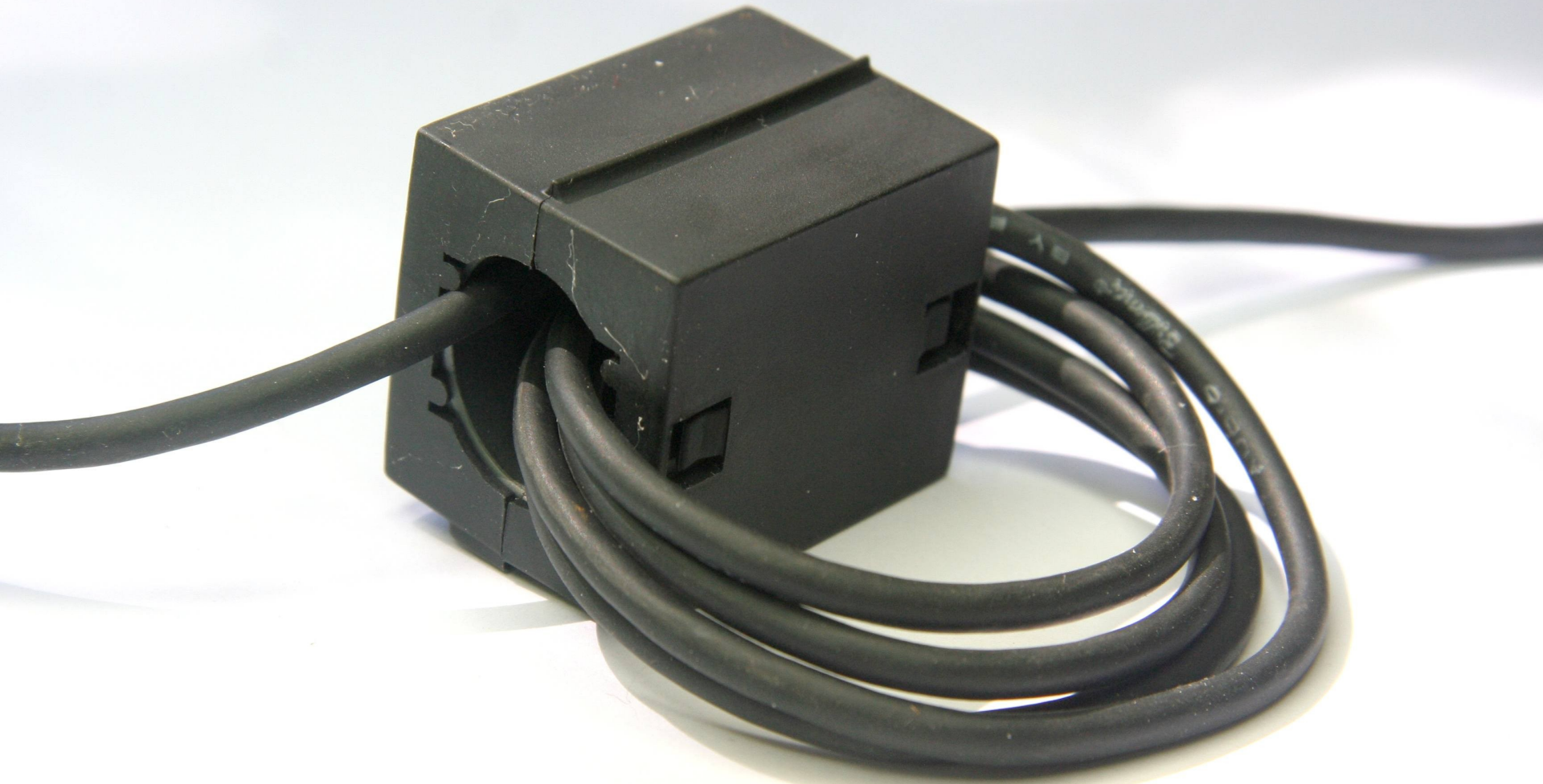

Use more turns for lower bands

An Effective Choke for 2-10 MHz



14 turns around a #31 core

Ferrites and High Current

- **If both conductors of high power circuits are wound through the core, the fields cancel, so only the common mode current contributes to saturation**
- **Ferrite common mode chokes are safe and effective on loudspeaker and power wiring**
- **Common mode chokes have no effect on audio, video, or control system signals, which are all differential signals**

If you can't easily remove the connector

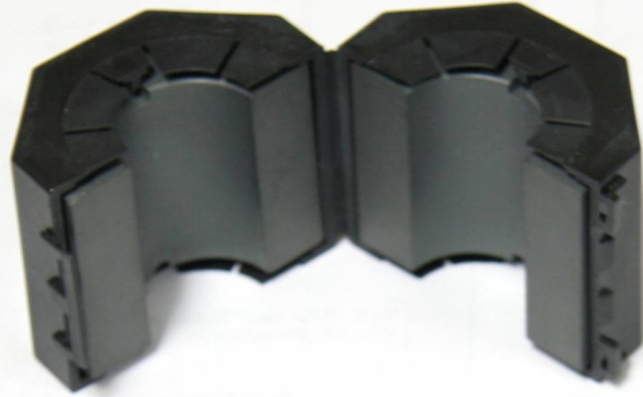

1" i.d.



Biggest Clamp-On, #31

Sometimes you can't
remove the connector



Criteria for Good Suppression

- **Choke must be predominantly resistive**
 - **Low Q, near resonance, #31, #43 only**
 - **Use measured curves to set resonance**
- **1,000 ohms is a minimum design goal**
- **Try for 5k ohms or more**
 - **Use number of turns to set resonance**
 - **Use chokes in series to get more resistance**

Threshold Effect

- The “antenna” (cable being choked) has some Z by itself
- The ferrite choke should add enough series R that the resulting Z is at least $2x$ the series Z of the “antenna” circuit without the choke. This reduces RF current by 6 dB
- Very little suppression occurs until the added R is at least half of the starting Z
- More choking impedance is better!

Criteria for Good Suppression

- Use only #31 material below 5 MHz
- Use #31 or #43 material above 5 MHz
 - #43 slightly better above 10 MHz

Covering Wider Frequency Ranges

- Use multiple chokes in series, each tuned to a different frequency range
- Put higher frequency choke closer to the noisy equipment
- Example:
 - 14 turns on #31 toroid for 2-10 MHz
 - 8 turns on #31 or #43 toroid for 10-30 MHz

Kill Antenna Current

- **Identify the most likely antennas (cables connected to equipment) radiating the noise**
- **Add a choke tuned to the ham frequencies where there is RFI**

Problems We Cannot Solve

Poor Equipment Shielding

- Internal wiring is transmitting antenna

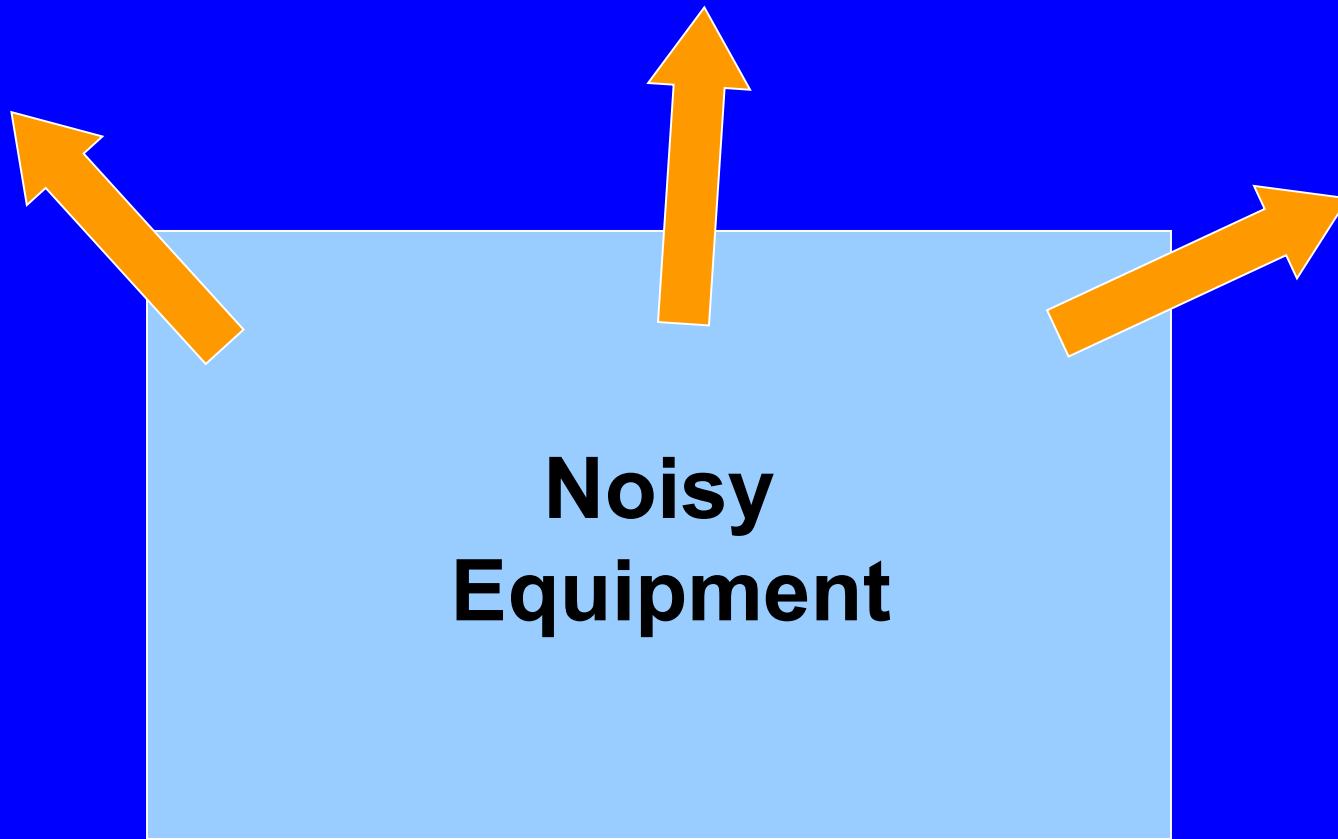

Poor Equipment Shielding

- **Circuit layout and construction cause internal wiring (including traces on circuit board) to radiate noise**
- **And there's no shielding to contain it**

****** The Bucket Treatment**

- Find a bucket large enough to hold the defective equipment**
- Fill it with water**
- Put the equipment in twice**
- Take it out once**

Solutions To Specific Problems

Twisted pair cables minimizes radiation of differential noise



Use #10 twisted pair for AC and DC wiring in solar systems, variable speed drive motors, and other noisy systems

Cable Problems – Paired Cable

- **Always use twisted pair for cables carrying noisy currents**
 - **Strongly resists radiation and reception**
 - **Is far more important than a cable shield**
- **Replace zip cord with twisted pair**
 - **AC power**
 - **DC power (solar systems, other noise sources)**
 - **Twisted pair 20-30dB better rejection than zip cord (glorified or otherwise)**

Make Your Own Twisted Pair

- Buy white and black #12 or #10 stranded THHN (house wire) from a big box store
- Lay out equal lengths of both colors, place one end of each together in a bench vise, put the other ends in a hand drill and twist slowly, keeping tension on the pair of wires
- Twist more tightly than you think you need – the twist will un-ravel over time when tension is removed
- Let the twisted pair sit overnight so that it “remembers” the twist

Make Your Own Twisted Pair

- Twists/inch usually varies from one end to the other**
- More twists/inch improves HF rejection**
- Exact number of twists/in is not critical**
- The resulting twisted pair will be 10-20% shorter than what you started with**

RFI From DSL Modems

- **Use only CAT5/6 for telephone and DSL**
- **Use one pair for each circuit**
 - **Blue = hot, blue/white = return**
- **Add ferrite chokes to all wiring**
 - **tune to about 2 MHz**
 - **30 turns on one #31 toroid**
 - **22 turns on two #31 toroids**
- **Place choke very close to DSL modem**
- **Use additional choke(s) if needed**

RFI From Battery Chargers

- **Treat it like any other switching power supply – choke the antennas!**
- **What are the antennas?**
 - **The AC power line**
 - **The DC cable, if there is one**

Variable Speed Drive Motors

- **Large ones control motors running**
 - elevators
 - geothermal systems
- **Small ones control motors in**
 - heating and air conditioning systems
 - treadmills
- **Symptoms look like SMPS noise**

Variable Speed Drive Motors

- **Operate by chopping DC to form a variable width pulse**
 - **10-20 kHz typical switching frequencies**
 - **Harmonics extend to HF bands**
- **Wiring between controller and motor carries this current**
 - **Hot and return conductors are often widely separated**
 - **Large magnetic field, “good” antenna**

Variable Speed Drive Motors

- **Contact the manufacturer, talk to their technical people, explain the problem, and ask for a solution**
- **Many manufacturers have optional modification kits to solve RFI issues**
- **Solutions can include**
 - **Slowing the rise time to reduce harmonics**
 - **Using twisted pair for conductors inside the box between motor and controller**

Outside the Box Solutions

- **Add ferrite common mode choke to the AC line to kill RF current**
 - **Follow Choke Cookbook for small coax in k9yc.com/RFI-Ham.pdf**
- **If more suppression is needed, add AC line filter bonded to frame of unit**
 - **May require modification to install it**

Power Line Filters

- **Are differential filters for phase (hot) and neutral**
- **Green wire passes by the filter (on the shielding enclosure)**
- **Green wire usually carries the noise as a common mode signal**

Power Line Filters

- Specs say they suppress common mode, but what they call common mode is voltage between neutral and equipment ground (the green wire)
- They kill common mode current ONLY if their case is bonded to the shielding enclosure, which fixes the “Pin One-Like” Problem

These Power Line Filters, If Bonded to the Shielding Enclosure of the Noise Source, Can Kill Common Mode Noise

End of filter mounted to panel has standard IEC power connector



Power Line Filters

- Power line filters do **NOT** kill common mode current if they are external to equipment
- This filter is a waste of money!



Sources of Power Line Filters

- **HSC (Halted) usually has a lot of good power line filters halted.com**
 - **They've moved to 3051 Corvin Dr in Santa Clara (one exit east of old warehouse, other side of Central Expressway from HRO's old Sunnyvale store)**

Ethernet Birdies

- **Identifying Ethernet birdies**
 - **Stable, wide tolerance, modulated**
 - **Near 14,030 kHz, 21,052 kHz, low end of 10M CW, low end of 6M**
 - **Multiple signals – you will hear your neighbors too, each on a slightly different frequency**
 - **Kill power to your router to see which birdies go away, work on those carriers – they're yours!**

Ethernet Birdies

- **Killing Ethernet birdies**
 - Wind each cable around toroid
 - 6-8 turns usually about right
 - Don't forget power supply cable
 - Some trash remains due to poorly shielded box
- **Use shortest cables practical**
 - Longer cable is better antenna
 - Longer cable is OK to add choke(s)

Ethernet Birdies

- **When you've killed your own, you'll still hear your neighbors**
- **Only present on wired Ethernet**
- **And on cable from cable modem to WiFi Router**
- **Use Wi-Fi instead**
 - **Choke only the cables to router and DSL or cable modem**

Leakage From Cable and DSL Modems

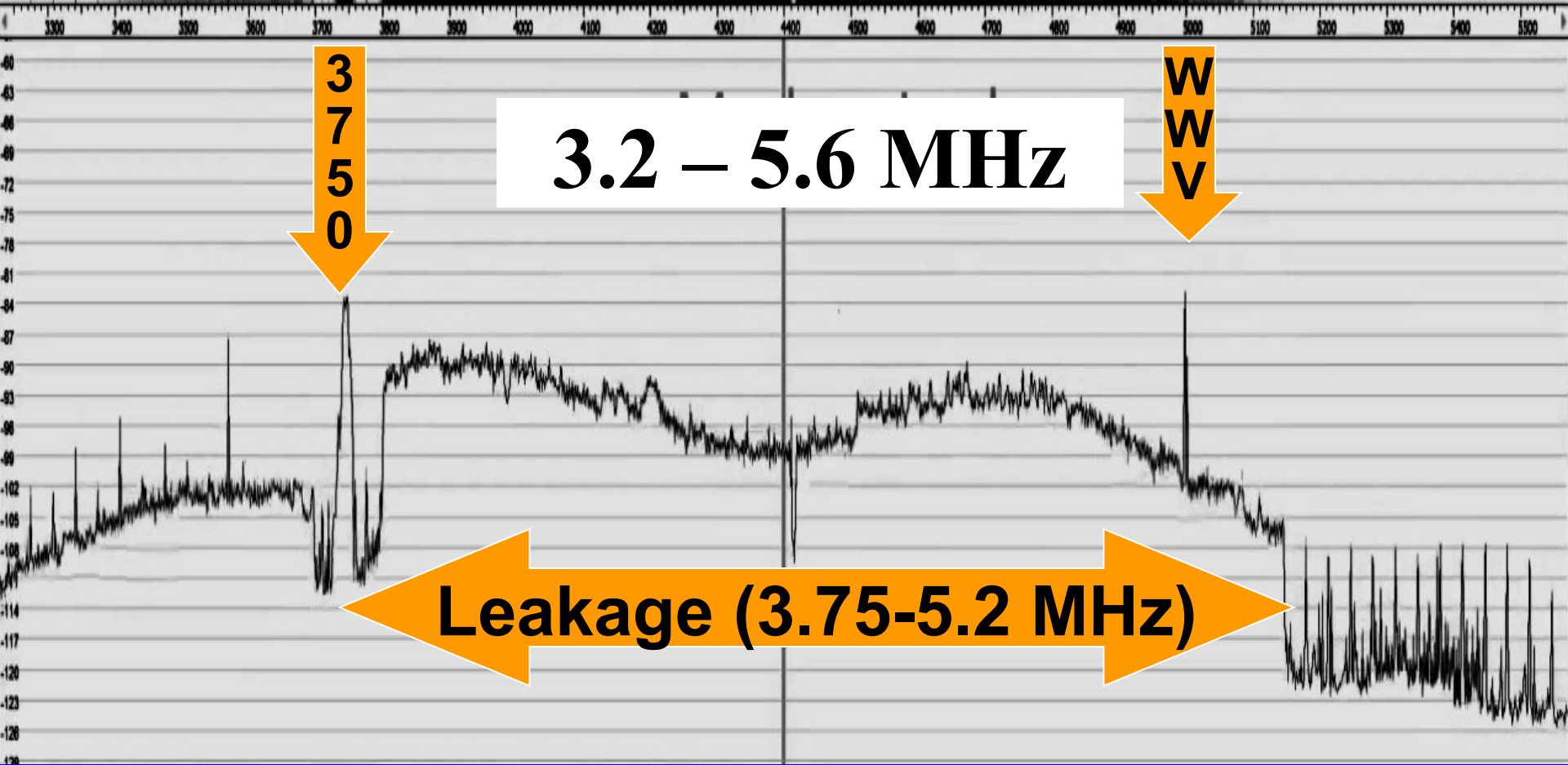

- This is the return data the modem sends back to the system

Killing Leakage from Modems

- **Choke all cables connected to DSL and cable modems**
- **10 turns on #31 2.4-in diameter toroid**
- **DSL and cable companies are in denial**
- **To solve this problem, every installation within range of your station must be cleaned up!**

Plasma TV Sets

- **Produces severe interference**
- **Caused by magnetic fields produced by high currents on wiring within the plasma display itself**
- **Spectrum of interference will vary with the DTV standard being displayed**
- **Only known fix is to replace the set with one using a CRT or an LED display**
- **Buy your neighbor a new TV!**

3.500.0 3.514.45 3.550.0

80M With Plasma TV – 50 kHz

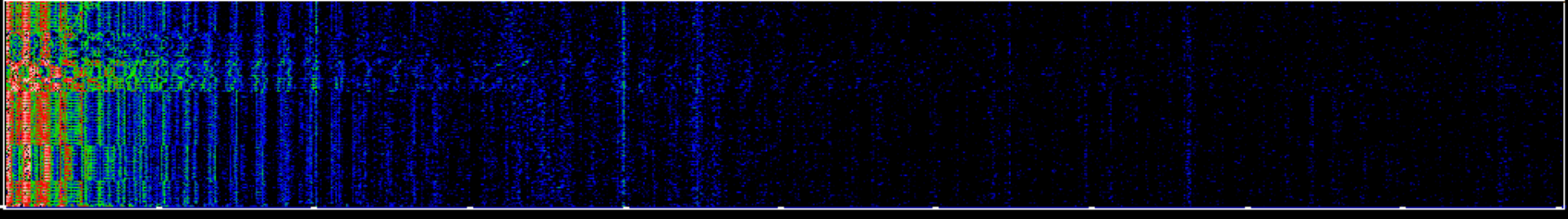
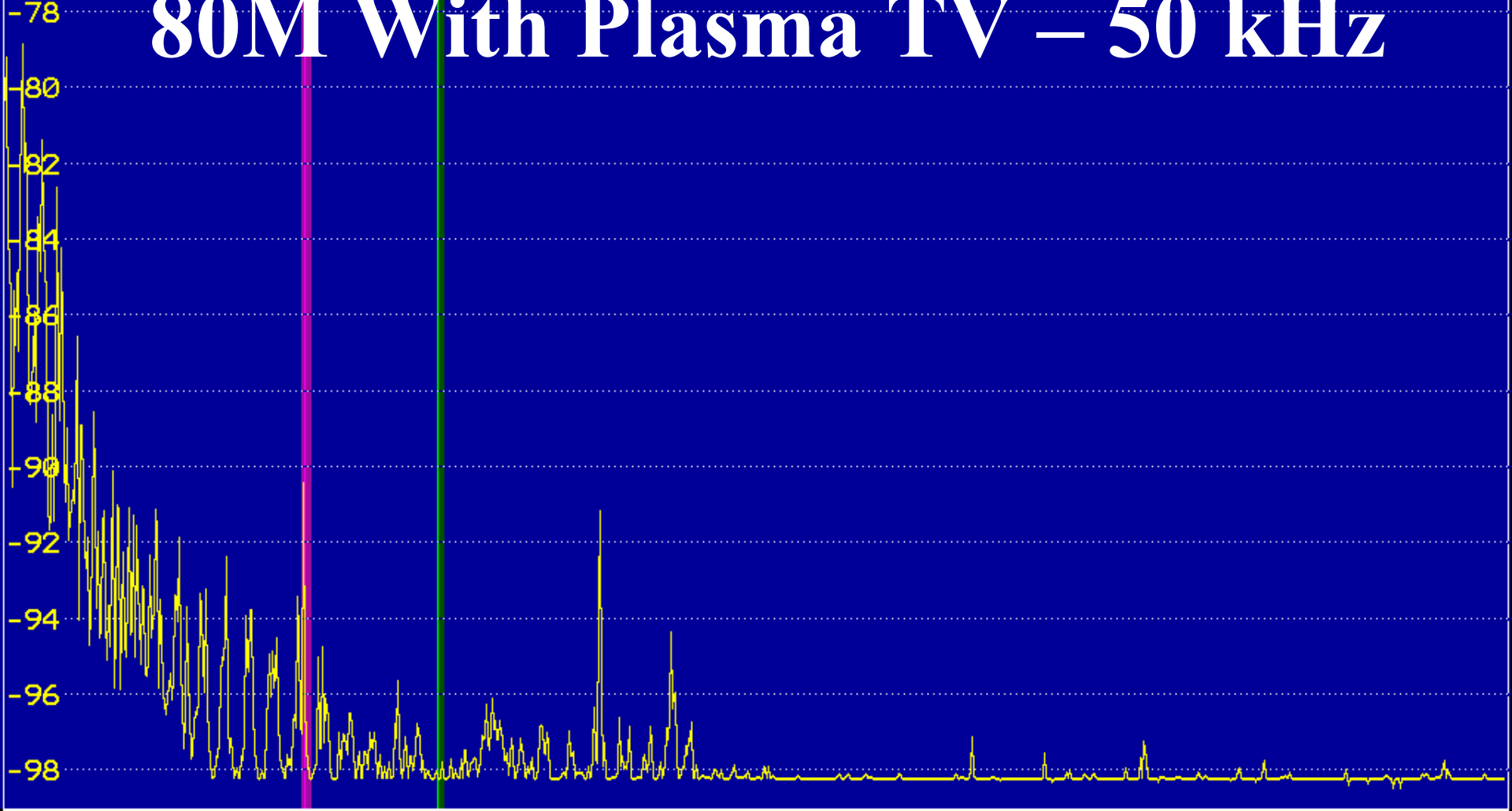

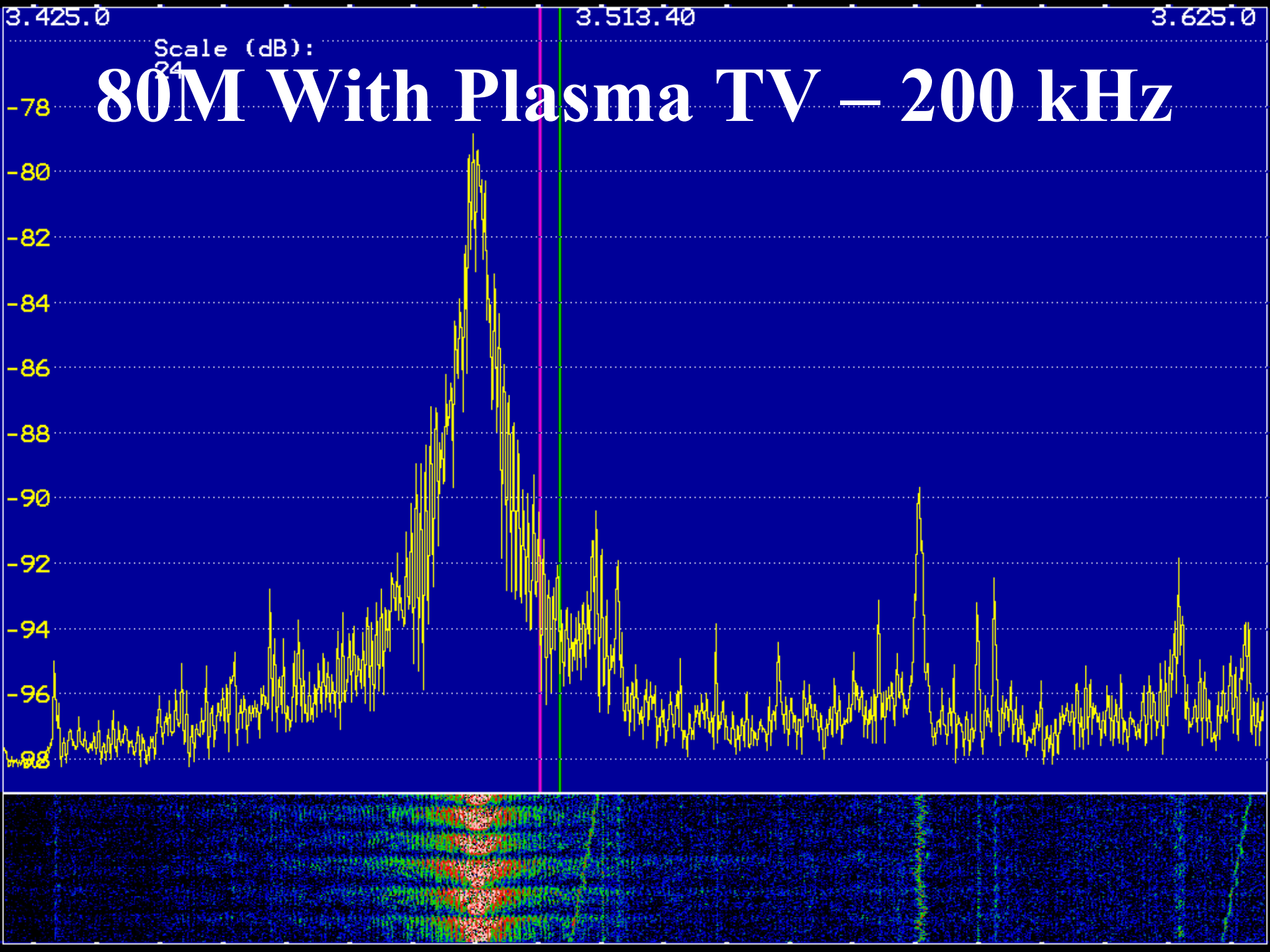

3.500.0

3.505.02

3.510.0

80M With Plasma TV – 10 kHz

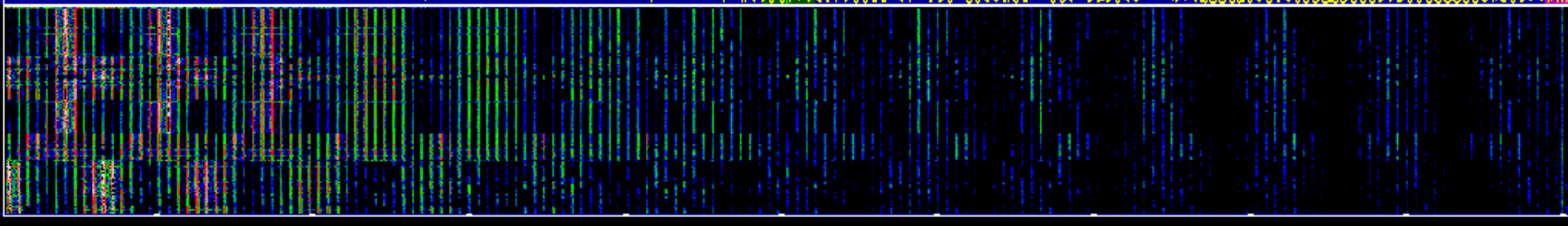
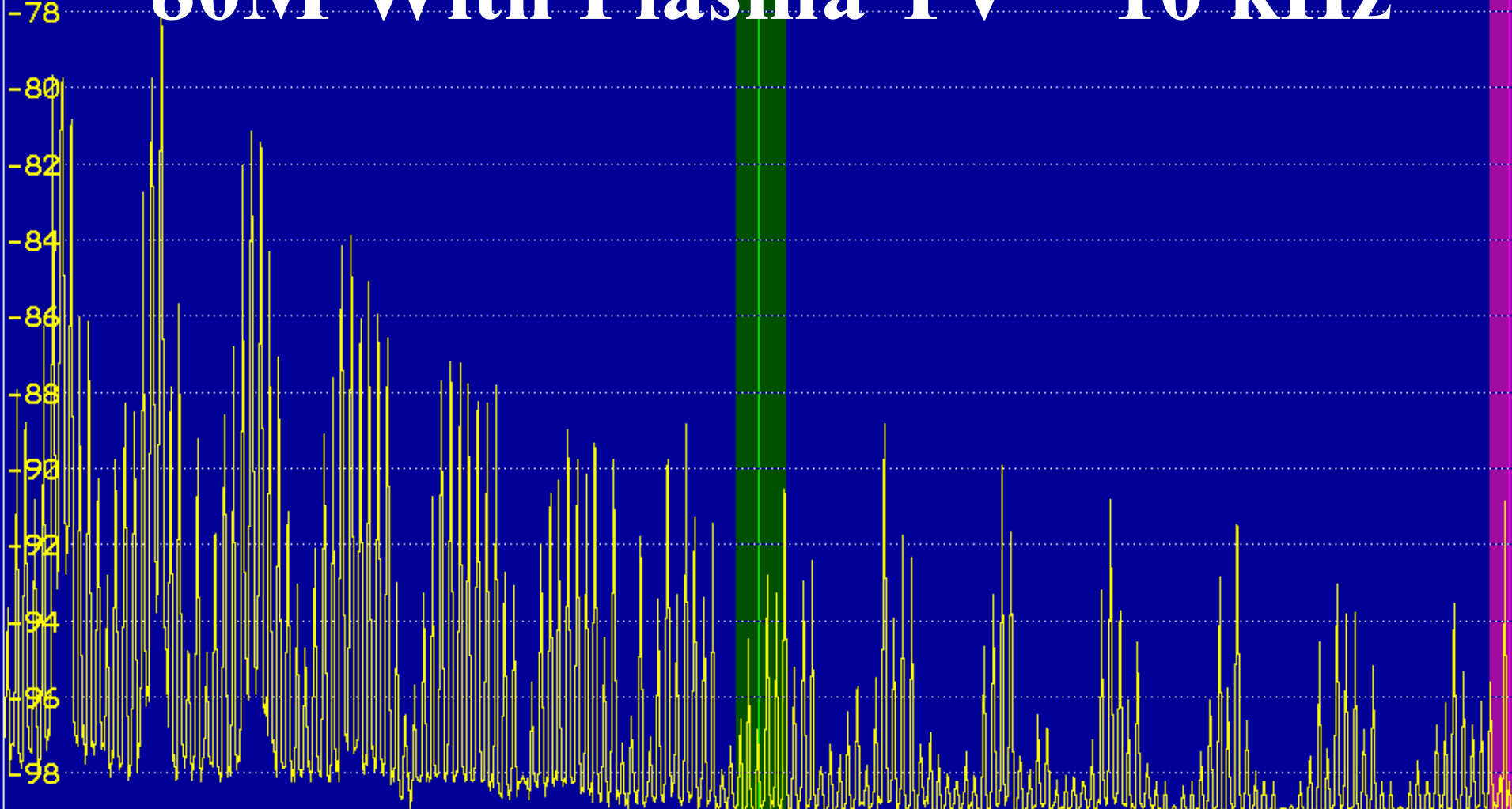

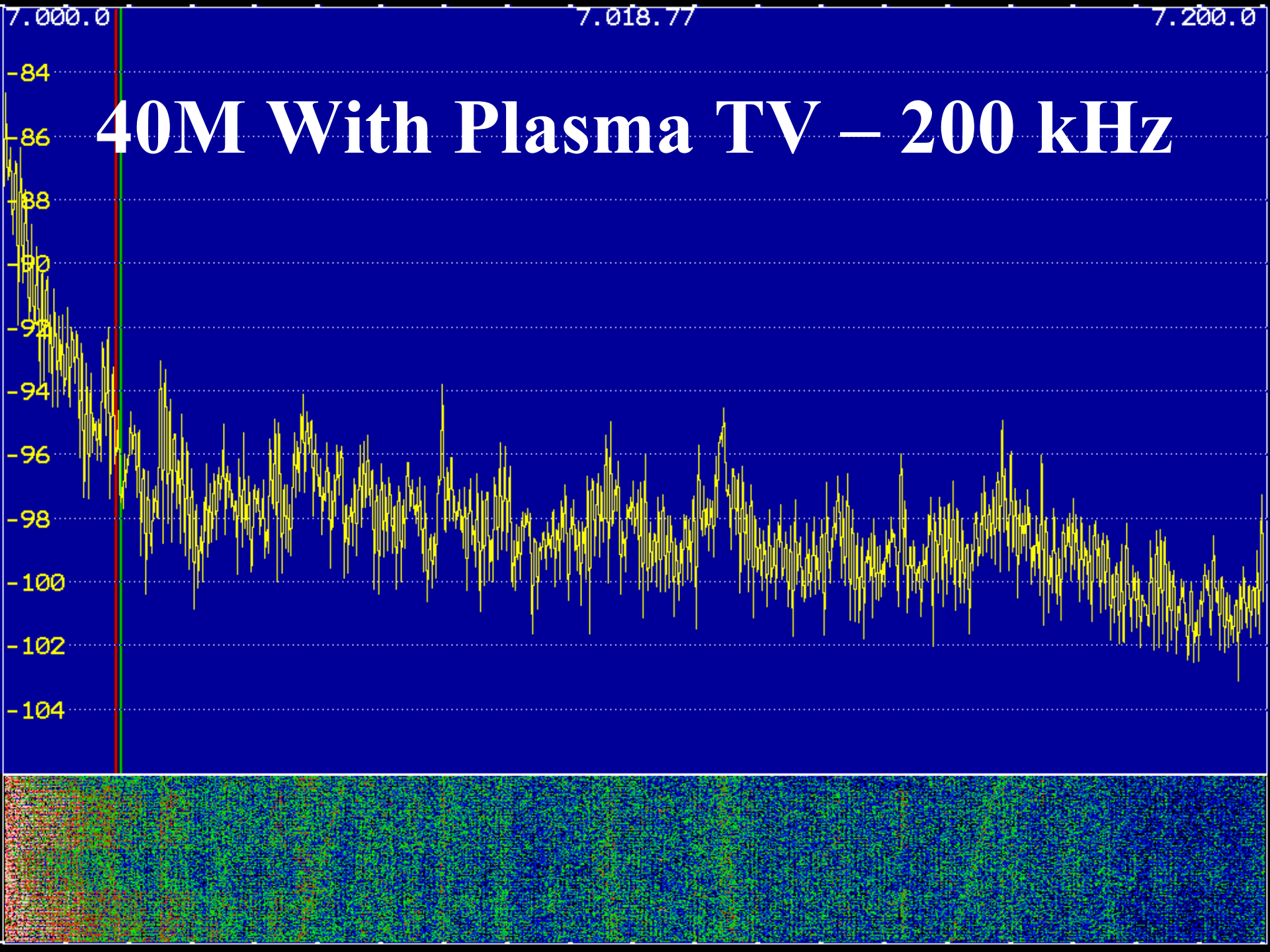

Plasma TV on 160M @ WD8DSB

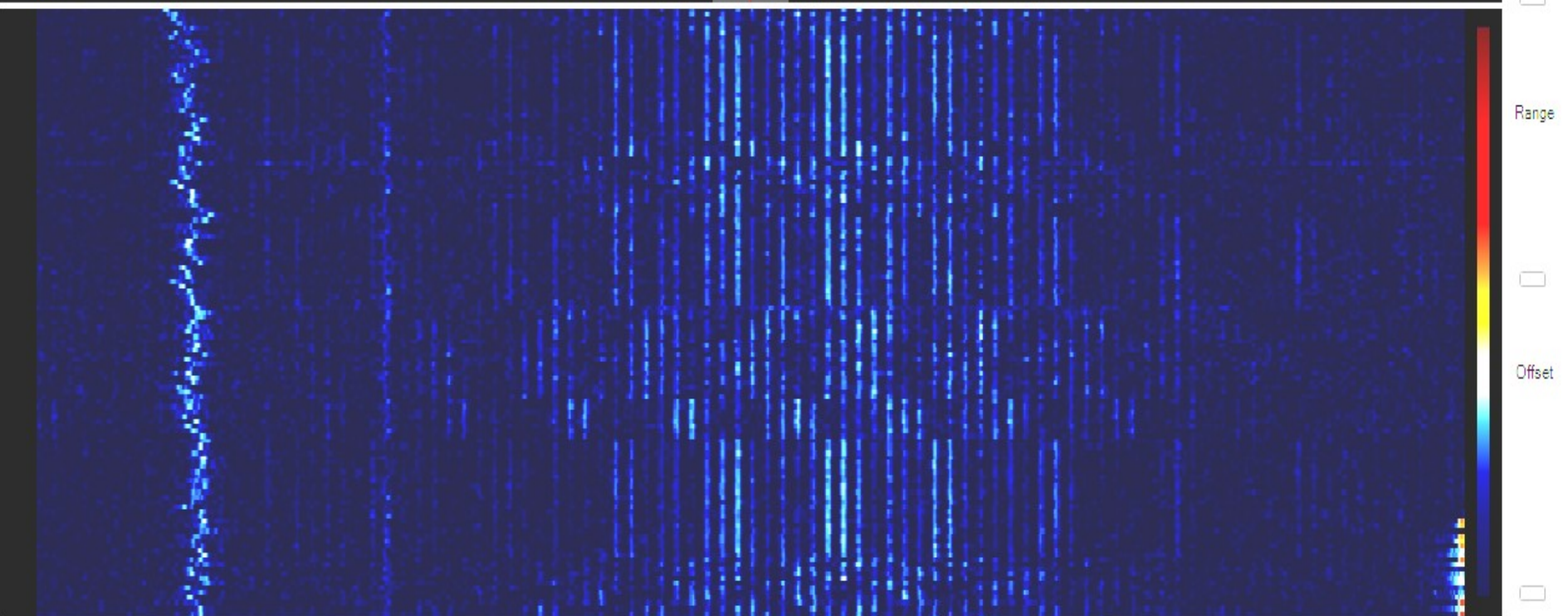
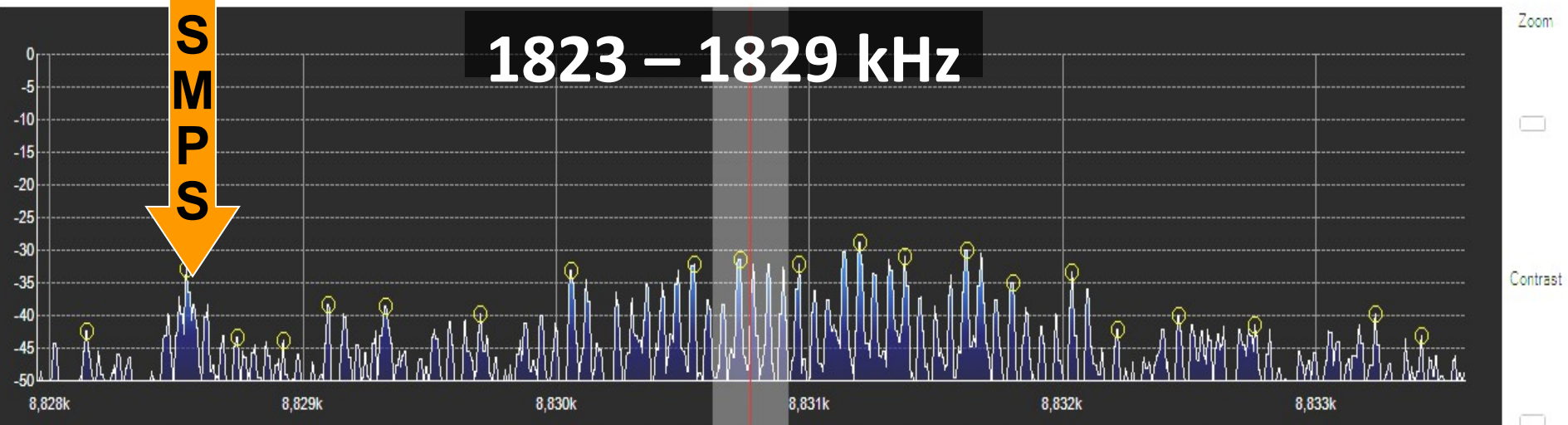

Plasma TV 0n 75M – 190 kHz

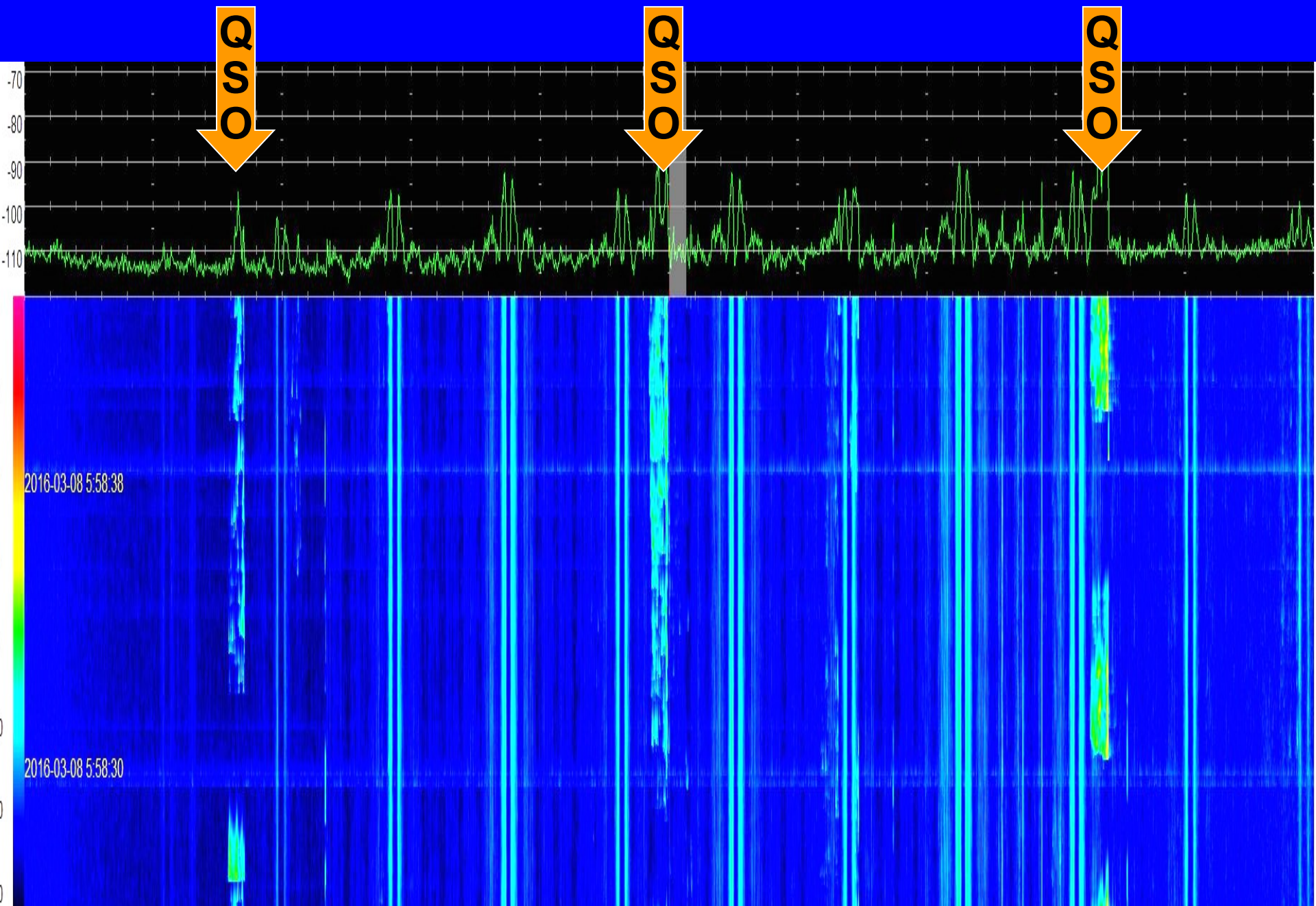

Fluorescent Lighting

- **Residential ballasts (FCC Class B) are much quieter than industrial (Class A)**
 - **Replace Class A ballast with Class B**
 - **Consider replacing tubes with LED tubes**
 - **Buy LED tubes that don't work with ballasts from earthled.com**
 - **Must rewire fixture to bypass the ballast**
- Or**
- **Buy direct replacements at big box stores**
 - **Work with the ballast, no rewiring required**

Grow Lights

- **Are high intensity, high power lights**
- **Require a ballast, that's what's noisy**
- **W0IVJ designed a filter, built by W7LOZ, that works on the lighting side of the ballast**
- **<http://growershouse.com/revolution-ballast-emi-filter-reduce-rf-emi>**
- **Galaxy Grow Amp model 90220 may pass Part 18, may be quiet (depends on wiring)**
- **Use twisted pair on wiring to the lamp**
- **Add ferrite choke on AC line if needed**

Grow Lights

- **Don't treat grower as your enemy**
- **“Maybe we can help each other out here”**
- **RF noise from growlights exposes growers to others**
- **Most growers don't want to draw attention to themselves so may appreciate your help in killing RF noise**
- **Make it clear that you don't care about what they're growing, only the RF noise**
- **Live and let live is a great attitude**

Low Voltage Lighting

- **Can Run on 24V AC or DC but most runs on 24VDC with an SMPS**
- **The SMPS is sold by electrical supply stores as an “electronic transformer”**
- **All I’ve seen are very noisy, unlabeled, and violate FCC Rules**
- **Real transformers will work fine, but those big enough to provide the required current are too large to fit in electrical backboxes**
- **Choke both AC and DC wiring**

Track Lighting

- Line voltage tracks carry 120VAC
 - Many use 120V lamps, and are quiet
 - Many use 24V lamps with SMPS in the base of the fixture, and are noisy
 - Choke AC wiring where it enters the track
- Low voltage tracks carry 24V, usually DC, use 24V lamps, and are fed by an SMPS
 - Use a real 24V transformer if possible
 - If an SMPS is used, choke both the 120VAC line and 24VDC at the SMPS

LED Lighting

- **A very efficient light source**
- **Require far less power to produce the same light as an incandescent bulb, and about half as much as a fluorescent**
- **Run on very low voltages, low current**
- **Quiet power supplies are easy to build**
- **1A at 12V provides a lot of light**
- **Easy to run from small linear wall warts**

LED Lighting

- **Big box stores sell LED replacements for standard bulbs in many sizes**
- **ARRL Labs tests show most are quiet**
- **Phillips bulbs seem to be the quietest**
- **Wired Communications (they have a booth) sells LED lighting in many useful sizes and shapes as well as accessories**
 - **My shack is lit with four tracks, that draw 1A from my 12VDC shack system**
 - **I do not recommend their power supplies**

UPS Units

- **A UPS unit keeps a battery on float charge when it has power**
 - **There's a battery charger, usually an SMPS**
- **A UPS has an inverter that converts it's battery power to 120VAC when power fails**
 - **Produces a “modified sine wave,” which is really multiple square waves**

UPS Units

- **Even on standby, a UPS can be noisy**
- **When the inverter is running, it's likely to be very noisy**
- **Treat a UPS like any other SMPS**
- **Choke both input and output wiring**
- **When killing power to chase noise, turn off everything connected to the UPS and then the UPS itself**

DC-AC Inverters

- Buy only units rated FCC Part 15 Class B
- Even a good unit may requires filtering
- This one ran logging computer in mobile setup



DC-AC Inverters

- The extreme choking shown here was required because it ran a logging computer in a mobile setup, so it was very close to the antenna



And this is a good one!

USB-Powered Equipment

- **Some contain an SMPS that converts USB power (5VDC) to higher voltage for power amp**
- **W6GJB traced massive noise in his shack to USB powered speakers**
- **The noise was present on every cable connected to the computer**
- **He found it using a current probe**

RF Current Probes



**Kenwood
TH-F6A**

MFJ-805

RF Current Probe

- **MFJ-805 (\$100)**
- **Or build your own**
 - Cheap if you have a good junkbox
 - w8ji.com/building_a_current_meter.htm
 - ifwtech.co.uk/g3sek/clamp-on/clamp-on.htm
- **Portable radio using a loopstick antenna are much more sensitive**
 - **Tecsun PL660**
 - **Kenwood TH-F6A**

Solar Power Systems Are Noise Sources

- Charge regulators pulse battery current, produce many strong harmonics**
- DC to AC inverters are modified sine waves (lots of strong harmonic content)**
- Poor wiring techniques make noise worse**

Solar Power Systems – My Advice

- Don't Buy A Noisy System**
- Get it in writing that it must be RF-quiet to your satisfaction before they get paid in full**
- Make the sales contract say that your last payment isn't due until noise performance has been verified**
- Be prepared to do thorough testing within a reasonable time window (part of contract)**

Solar Power Systems – My Advice

- Before you buy, make sure that the vendor (installer) has talked to the equipment manufacturer(s) about RFI**
- Let him know that “standard” installations are likely to be a train wreck**
- Walk (run) away from a vendor who you aren't sure understands, or who hasn't given you detailed info from the mfrs**
- Don't try to fix a noisy system – it's a lot of work and it's expensive**

Solar Power Systems – What it Takes

- Use twisted pair for ALL power wiring, both AC and DC**
- When batteries are in series (they often are) twisted pair must run the entire loop, with one side broken at each battery**
- All wiring must be in steel conduit that is bonded to equipment enclosures at both ends (steel provides shielding)**
- AC line filters integral to equipment are required on all line-connected equipment**

Solar Power Systems – What It Takes

- **All equipment must be fully shielded, with feed-through caps on all DC lines and AC line filters on output wiring**

Fixing Noisy Solar Systems

- **Replace noisy charge regulator(s) with quiet one(s)**
- **Re-wire all DC circuits with twisted pair that follows the battery loop**
- **Replace noisy inverters with quiet ones that include integral AC line filters**
- **Add ferrite common mode chokes to AC and DC lines following guidelines in k9yc.com/RFI-Ham.pdf**

Finding Electronic Noise Sources Outside Your Home

What Direction Is It Coming From?

- When heard on a band with a directional antenna, rotate it**
- When heard on a band with multiple antennas, switch between them**
- Try to use a spectrum display – there are often multiple sources in the same and/or different directions**

Where To Look For Noise

- Chase it on frequencies where you hear it
- Start close to your antennas, expand your search as needed
- Walk close to home, get in your car to expand your search
- Strong noise sources or sources with good antennas can be miles away

Finding Power Line Noise Sources

Power Line Noise

- **Is created by arcing**
- **Contains all frequencies**
- **The power line conducts it and radiates it**
- **Standing waves on the power line creates peaks and dips at lower frequencies, making it nearly impossible to DF**
- **Higher frequencies radiated by wiring closer to the source**
- **Chase it at highest frequency you hear it**

Finding Power Line Noise Sources

- **Use an AM detector if possible**
- **Use directional antennas when possible**
- **Chase it on the highest frequency where you can hear it**
- **As noise gets stronger, you're getting closer, so go to higher frequencies**

Chasing Power Line Noise

- **Listen above 100 MHz with AM detector**
- **AM aircraft band (118 MHz – 137 MHz)**
- **VHF/UHF mobile rig or talkie that can be set to receive AM**
- **Tecsun PL660 covers AM aircraft band**

How I Chase Power Line Noise

- ***It's Impulse Noise***, so must be chased at **VHF/UHF**
- **Kenwood TM-V71A VHF/UHF Mobile Rig**
 - Mag-mount vertical
 - Set for AM detection
 - Memories programmed for 160 MHz, 300 MHz, 400 MHz, 550 MHz
- **Kenwood TH-F6A Talkie, rubber duck**
 - Programmed for AM on same frequencies

Setting VHF/UHF Rigs for AM

- **Some of the better rigs can be tuned for wide coverage receive, and can be set for AM**
- **While programming can usually be done from menus, it's usually much easier to use the manufacturer's computer software to program the memories**

How I Chase Power Line Noise

- **Drive around listening to 160 MHz AM on the mobile rig with VHF/UHF mag mount**
- **When the noise gets loud, shift to 300 MHz, 400 MHz, 550 MHz**
- **When it gets loudest at 550 MHz, get out of the car and listen with the talkie**
- **Hold talkie/duck close to chest to block reception from behind you**
- **Walk around turning body to find source**

Locating Power Line Noise

- **Very close to the source, it may help to remove rubber duck, use no antenna, or stick a very short wire into the antenna jack**
- **Compact directional antennas that can be handheld can be effective tools**
 - **Directional antennas must be used at their design frequency – for example, a small 440 MHz antenna on 440 MHz**
 - **Set radio for AM detector**
 - **Watch S-meter**

When You Find Power Line Noise

- **When you believe you have located the power pole that is the source, make note of**
 - **The street address (or lat/long if no street address)**
 - **All numbers on the pole**
- **Provide that information to the Power Company serving the area**
- **Contact ARRL for help if needed**
- **Contact state Public Utilities Commission if power company is unresponsive**

A Power Line Noise Source

These MOVs conduct on peaks of the AC cycle as they are beginning to fail, creating noise that Jeff heard 2 miles away.



Photo by Jeff, AC0C

MOVs On Power Lines



Photo by Jeff, AC0C
AC0C

Buying Ferrite Parts

FT-numbers are a Rip-Off!

- Invented by ham vendors to disguise the fact that they're all made by a company called Fair-Rite, so that they can charge you a lot more**
- Virtually all ferrite parts useful to hams are made by Fair-Rite**
- Best prices are from industrial vendors**
- But we have to know the part numbers**

Which Ferrite Parts to Buy?

LFair-Rite Part #	Shape	i.d. inch	o.d. inch	inch
0431164181	Clamp-on	0.5	1.55	1.22
0431173551	Clamp-on	0.74	1.15	1.65
0431177081	Clamp-on	1	1.7	2.2
2631803802	Toroid	1.4	2.4	.5

Finding More Fair-Rite Part Numbers

- **Fair-Rite has an excellent website and excellent catalog**
- **Thousands of different sizes, shapes**
- **Several dozen different mixes**
 - **#31, #43, #61, #73, etc.**
 - **Different chemical composition**
 - **Different RF properties**
 - **Optimized for different uses**

Where NOT To Buy Fair-Rite Parts

- **Ham Vendors are wildly expensive**
 - **Markups of 3x – 5x their cost**
 - **Use fake part numbers to charge more**
 - **Advertise in back of ham magazines**
 - **Often the wrong parts**
 - **Amidon, Palomar-Engineers, DX Eng**
 - **Kits and Parts (AKA The Toroid King)**

Where To Buy Fair-Rite Parts

- **Dexter Magnetics (near Chicago)**
- **Lodestone Pacific (Anaheim)**
- **Kreger Components (Virginia)**
- **Newark, Allied, Digikey**
- **These are industrial distributors, so they have big discounts for quantity**
- **The do not want to sell onesy-twosy**
- **Don't waste their time with small orders!**

How To Buy Fair-Rite Parts

- **Buy in quantity by combining orders with your friends, members of your local ham club**
- **Buy full box quantities (no breakage)**
- **Have vendor ship to one or two addresses central to your group or club(s)**
- **Do not reship to distant buyers**
 - **Expensive – they're heavy**
 - **Hard to pack well – they break easily**

How To Buy Fair-Rite Parts

- **When you know about how large your order will be, call several vendors for prices**
- **Ask what the quantities are for price breaks**
- **Tax and shipping will be charged – add to your quote to group buyers**
- **These vendors take credit cards and bill when they ship, so you can usually collect from group buyers in time to pay your credit card**

References

Applications notes, tutorials, and my AES papers are on my website for free download

<http://k9yc.com/publish.htm>

References

- **Henry Ott, *Electromagnetic Compatibility Engineering*, Wiley Interscience, 2009**
- **E. C. Snelling, *Soft Ferrites, Properties and Applications*, CRC Press, 1969**
- **E. C. Snelling and A. D. Giles, *Ferrites for Inductors and Transformers*, Research Study Press, 1983**

References

- *Fair-Rite Products Catalog* This 200-page catalog is a wealth of product data and applications guidance on practical ferrites
<http://www.fair-rite.com>
- *Ferroxcube Catalog and Applications Notes*
More online from another great ferrite manufacturer
<http://www.ferroxcube.com>

References

- *Noise Susceptibility in Analog and Digital Signal Processing Systems*, N. Muncy, JAES, June 1995
- *Radio Frequency Susceptibility of Capacitor Microphones*, Brown/Josephson (AES Preprint 5720, on my website)
- *Common Mode to Differential Mode Conversion in Shielded Twisted Pair Cables (Shield Current Induced Noise)*, Brown/Whitlock (AES Preprint 5747, on my website)
- *Testing for Radio Frequency Common Impedance Coupling in Microphones and Other Audio Equipment*, J. Brown (AES Preprint 5897, on my website)

References

- *A Novel Method of Testing for Susceptibility of Audio Equipment to Interference from Medium and High Frequency Broadcast Transmitters*, J. Brown (AES Preprint 5898, on my website)
- *New Understandings of the Use of Ferrites in the Prevention and Suppression of RF Interference to Audio Systems* , J. Brown (AES Preprint 6564, on my website)
- *Understanding How Ferrites Can Prevent and Eliminate RF Interference to Audio Systems*, J. Brown Self-published tutorial (on my website)
- *A Ham's Guide to RFI, Ferrites, Baluns, and Audio Interfacing*, J. Brown Self-published tutorial (on my website)

Killing Receive Noise

Jim Brown K9YC

k9yc@arrl.net

**Some materials have a
second resonance
(Fair-Rite #78)**

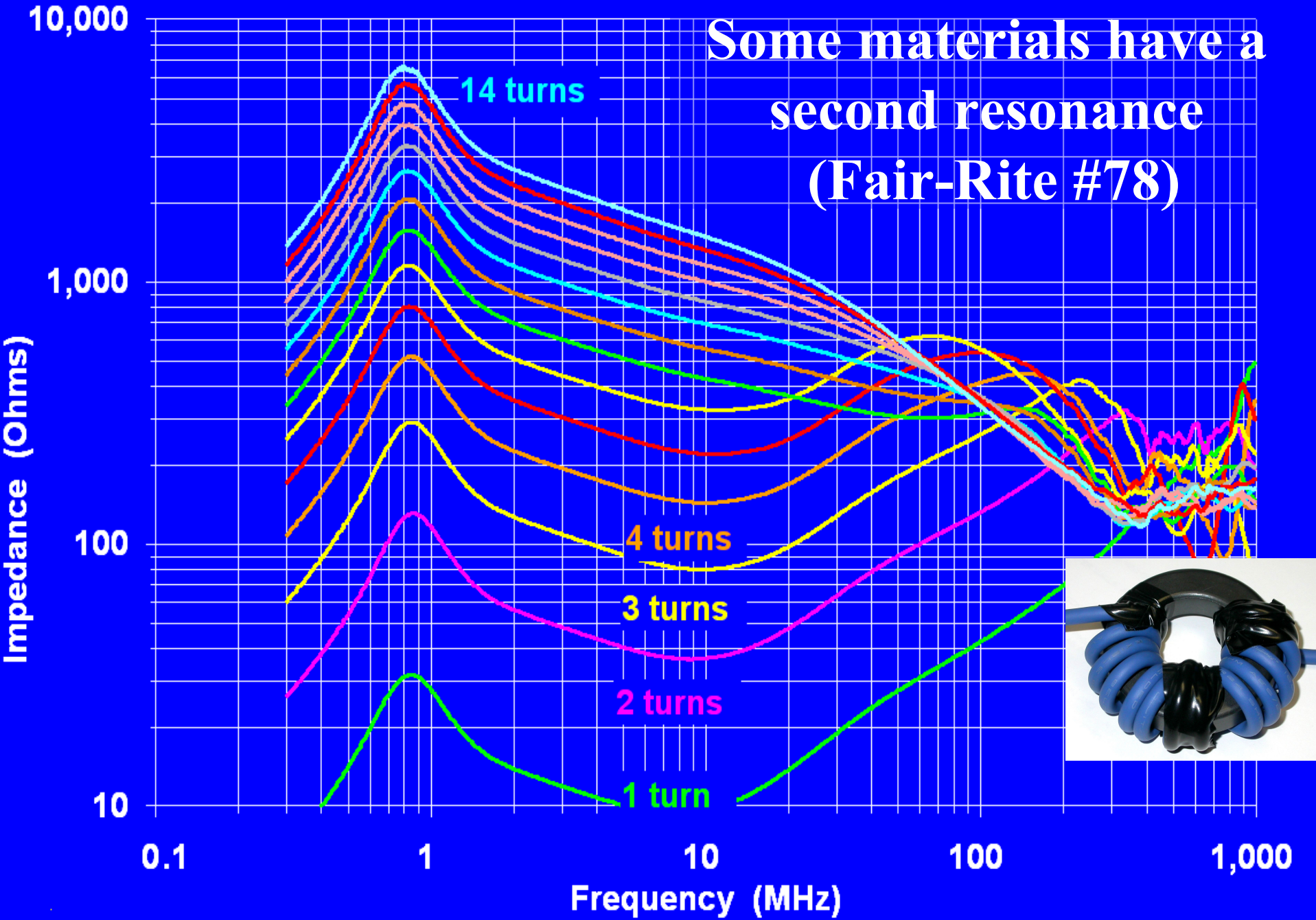

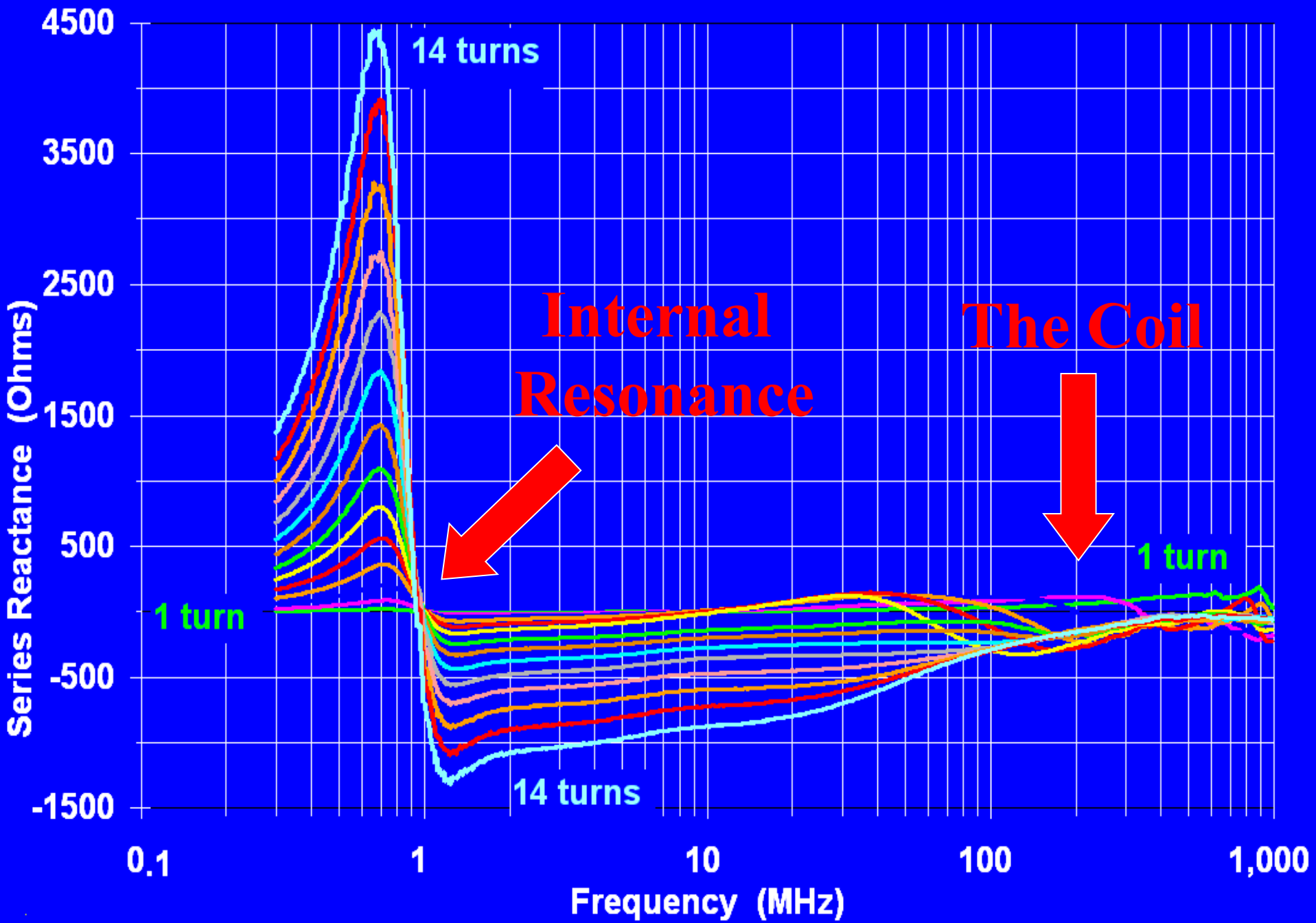

A Better Equivalent Circuit

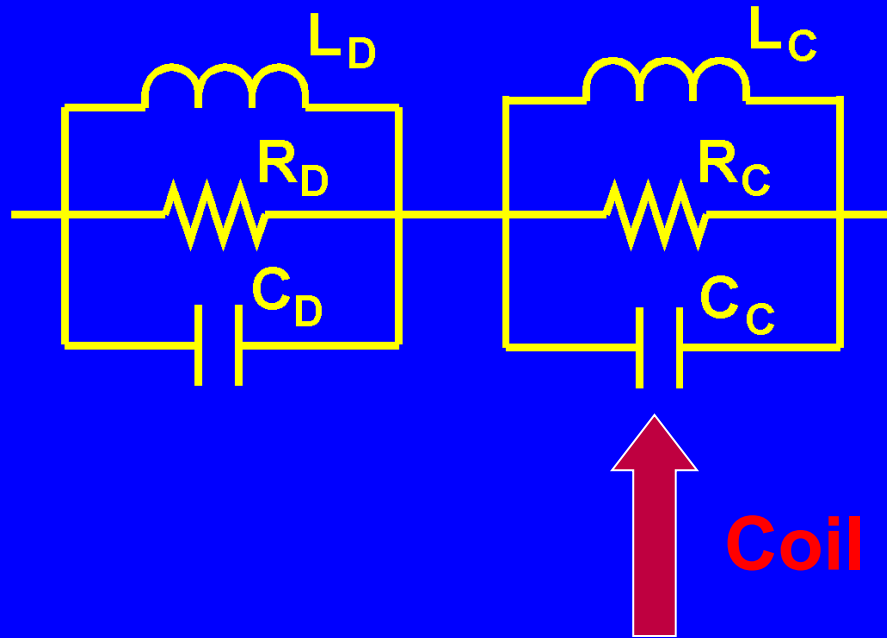

L_C is the inductance of the coil

C_C is the stray capacitance of the coil

R_C is the resistance of the wire.

L_C and C_C form the resonance that moves!

A Better Equivalent Circuit

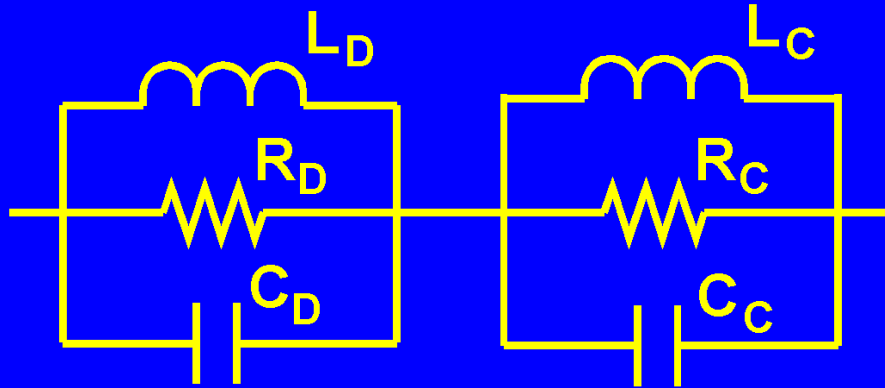

Ferrite



L_D and C_D represent the *dimensional* resonance of the ferrite itself

R_D is the loss within the ferrite

Fair-Rite Data for Biggest Clamp-On, #31

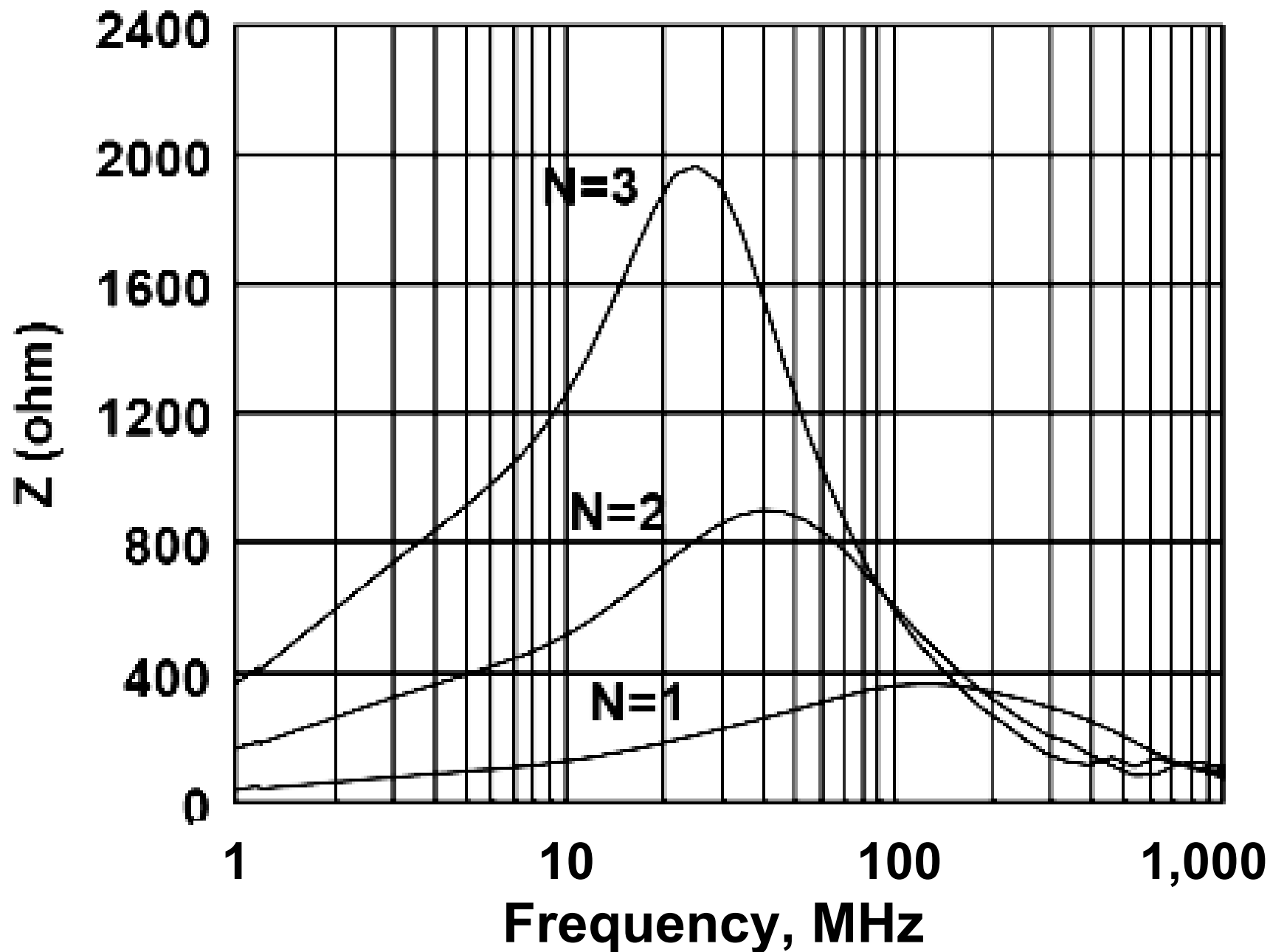

Line Filters Can Add Noise to Ground

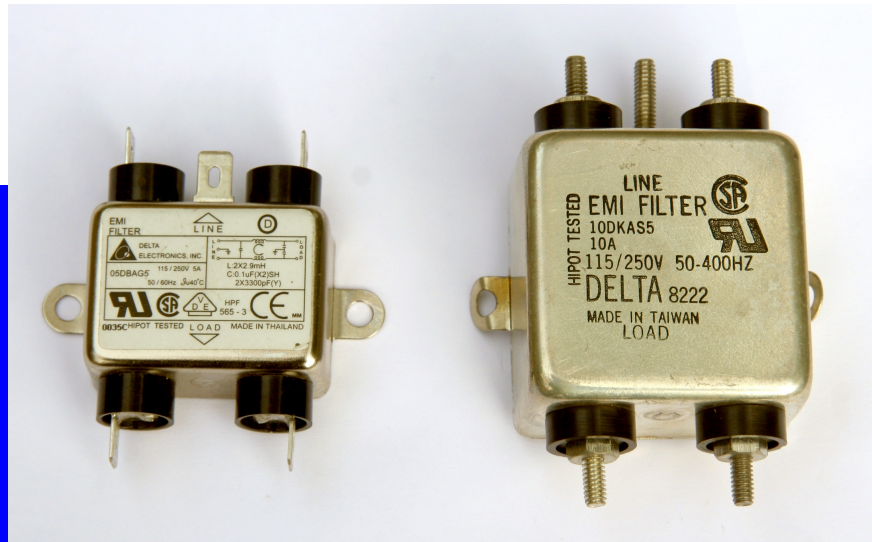
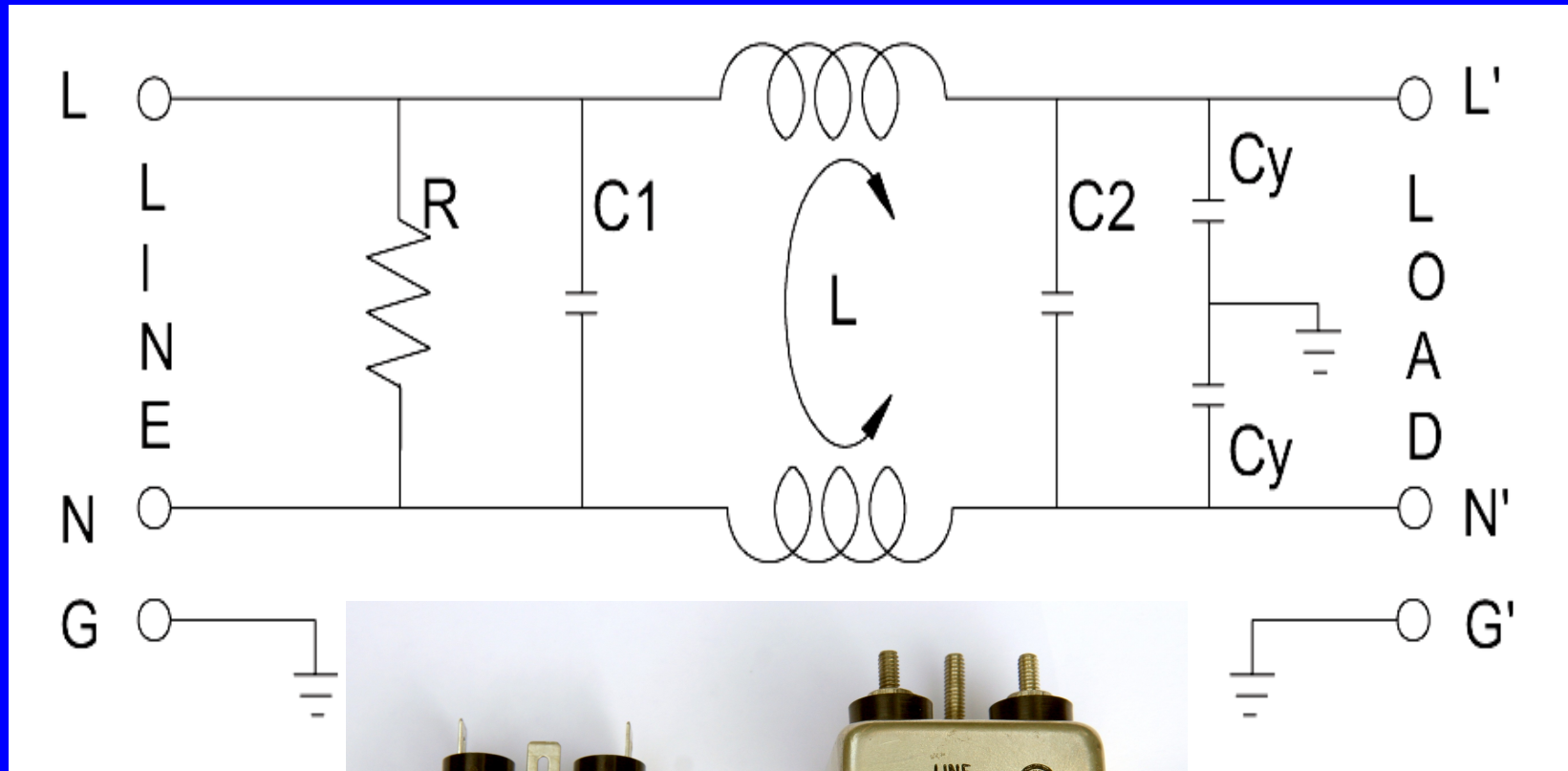

Why a Hump Instead of a Steady Carrier?

- Oscillators are *dithered* (FM-modulated by noise) to skirt FCC RFI rules
- That noise causes them to wobble around in frequency or drift, and the modulation makes them broad
- FCC rules limit the strength of carriers, so the FM noise moves some of power from carrier to sidebands

How Do Pin Problems Happen?

- Pin 1 of XL's go to chassis via circuit board and ¼" connectors (it's cheaper)
- XLR shell not connected to anything!
- RCA connectors not connected to chassis



Threshold Effect

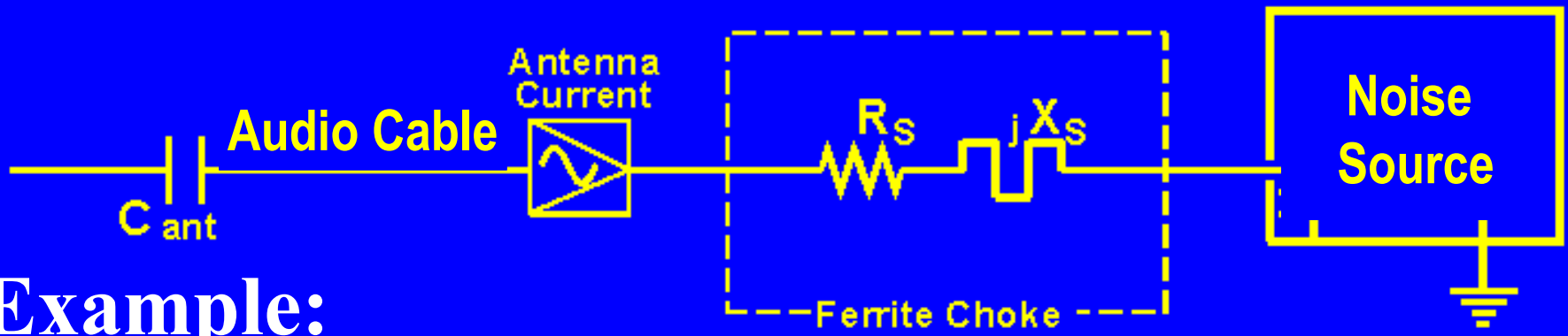

Example:

Our antenna is short, so looks capacitive

Without the choke, the total antenna circuit is $300 \angle -60^\circ \Omega$,

and we add a choke that is $300 \angle 60^\circ \Omega$,

$$Z_T = (150 - j260) + (150 + j260) = 300 \Omega$$

Our choke has not helped!

Threshold Effect

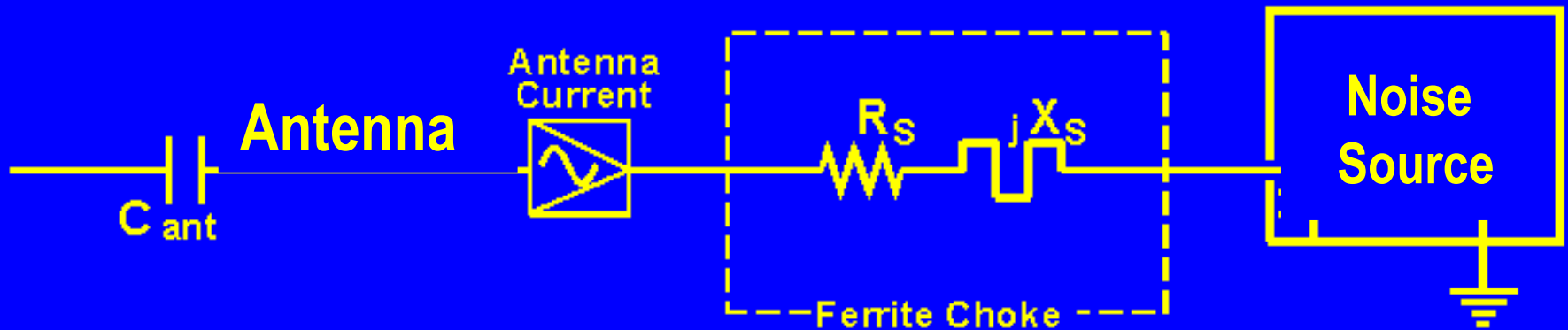

But if we make the choke larger (more turns or more cores in series), additional R_s will begin to reduce the current.

Increasing R_T to 425Ω (3 dB) reduces detected RF by 6 dB, and increasing R_T to 600Ω (6 dB) reduces detected RF by 12 dB (assuming no change in X_s).

It Takes a Ferrite Choke To Kill the Noise

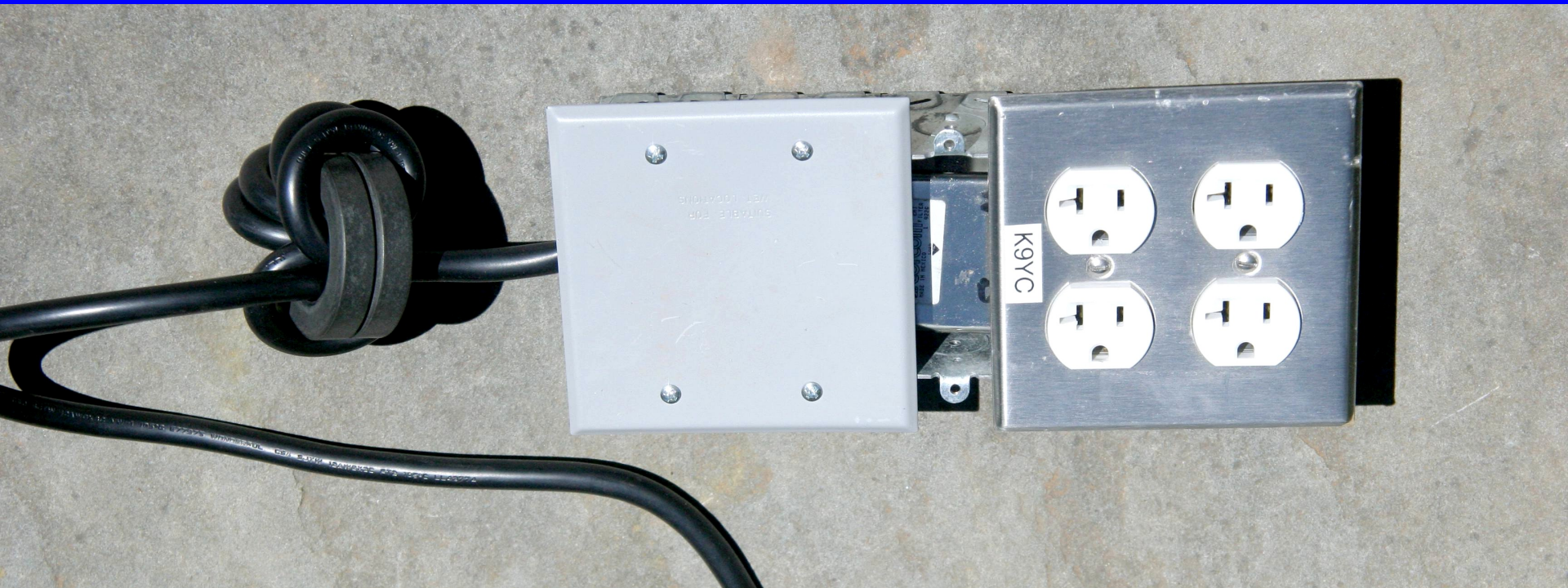

Differential Mode Signals

- **Current flow is in opposite directions on conductors in a signal circuit**
- **Voltage difference between conductors**
- **Noise can be differential mode too**



Common Mode Transmission

- **Common mode current turns a feedline into an antenna (or makes it part of the antenna it is feeding)**
- **That's why we choke the feedline at the antenna –**
- **The choke prevents noise picked up on the feedline from being coupled to the antenna, and from there back down the inside of the feedline to the receiver!**

Variable-Speed Drive Motors

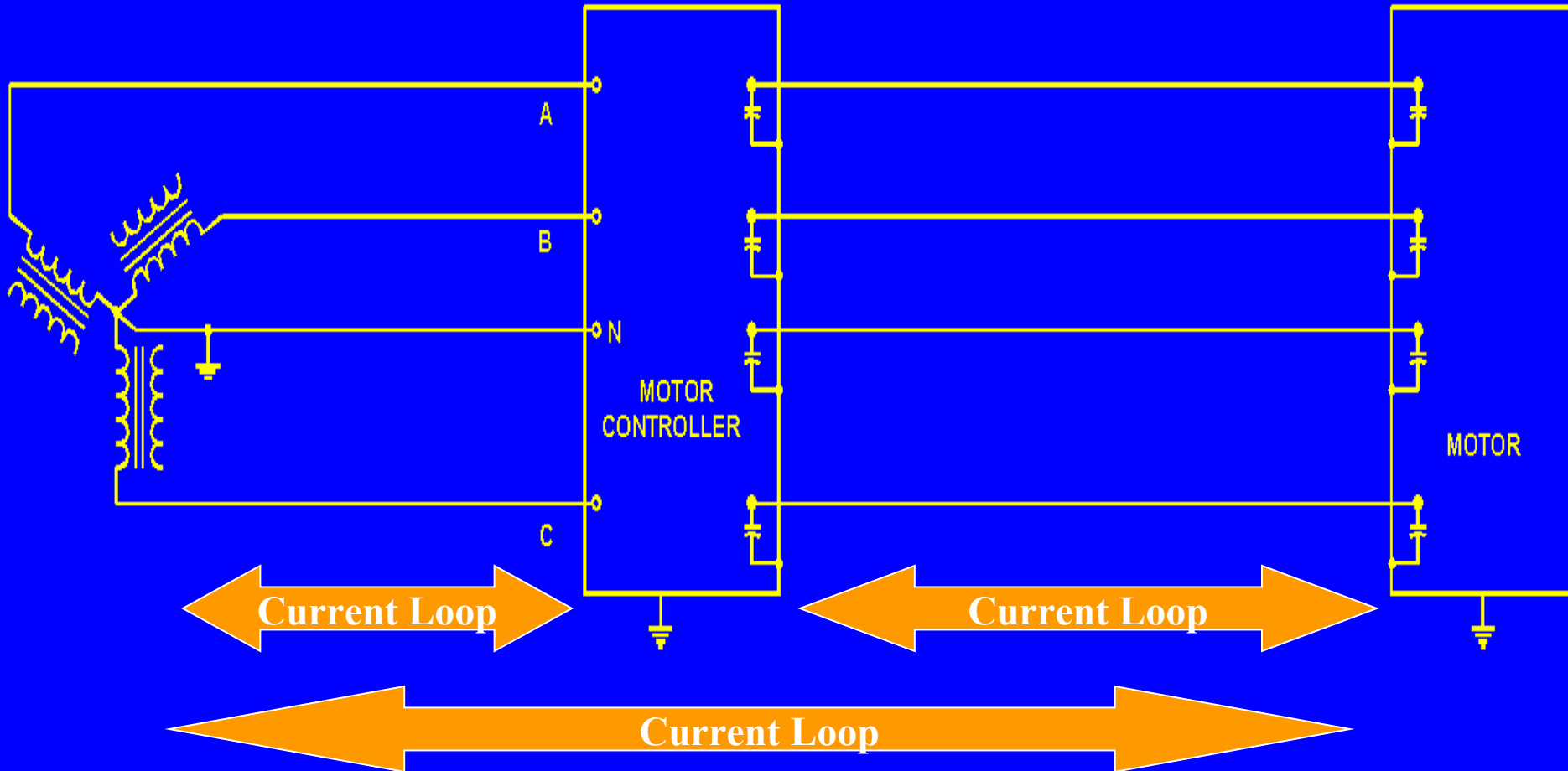

#61 Mix Suppresses UHF

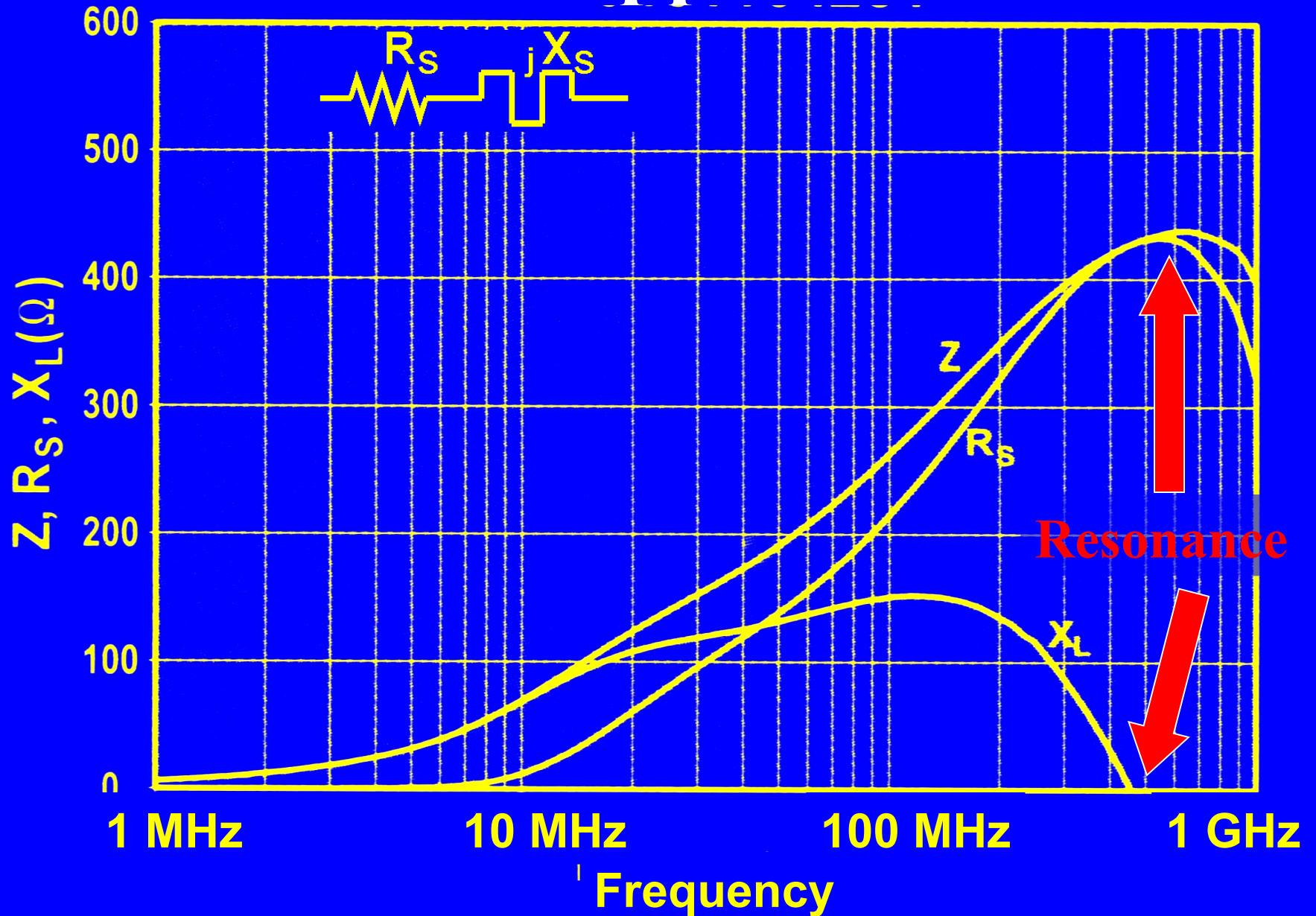

VHF (#43) mix, different lengths!

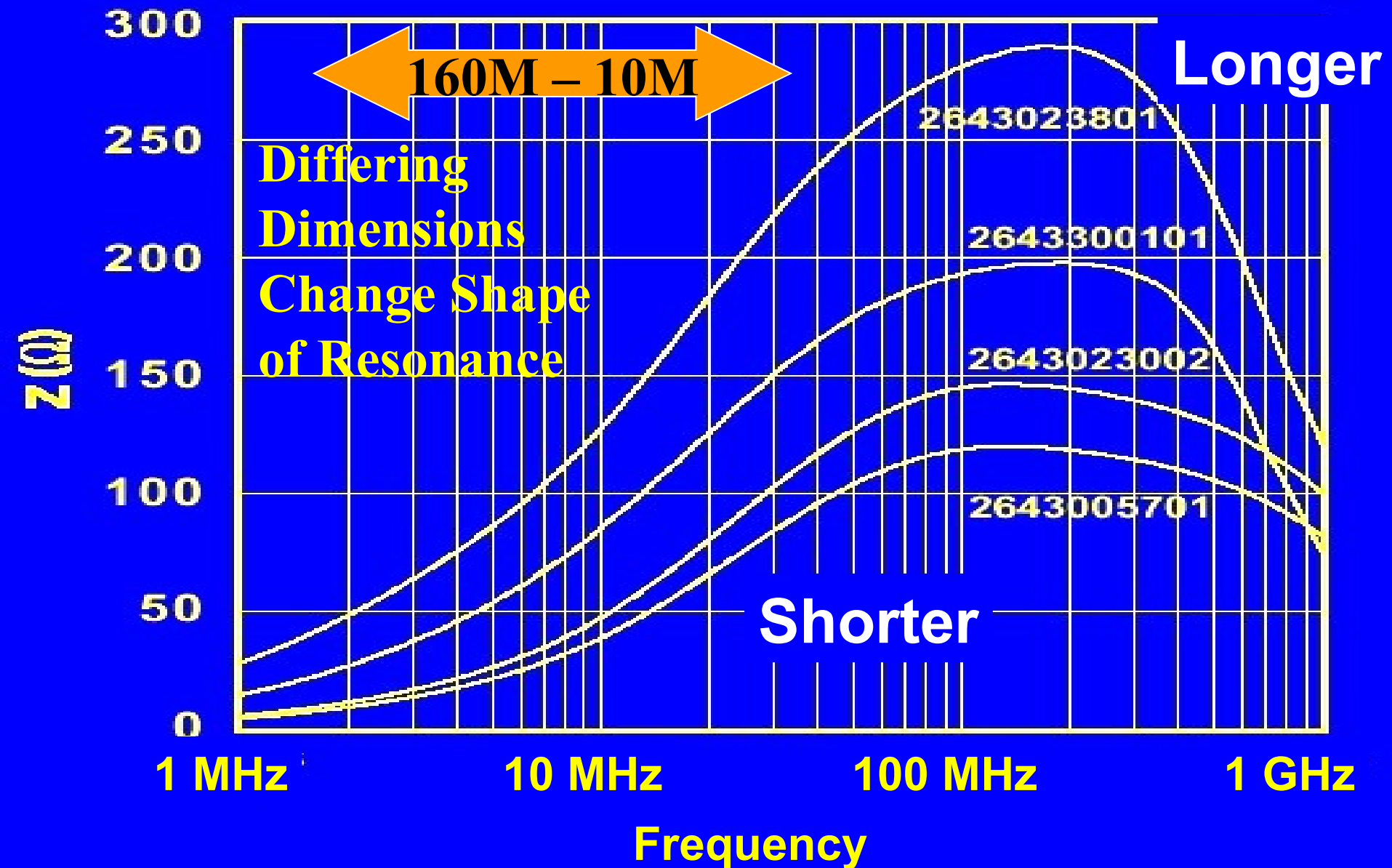

Antennas Inside Equipment

- **Wires and circuit traces are antennas too**
- **These problems must be solved by the equipment manufacturer**

Shielding Failures

- **Plastic cases**
- **Openings in metal cases**
 - **Gaps between pieces of metal case**
 - **Paint at joint of metal surfaces creates a slot opening, RF escapes**

Shielding Failures

- **Cables enter metal case but shield is not bonded to case**
- **Single wire enters case with no feed-through or bypass cap to case**
- **Breaking a ground plane under a trace**
 - **Defeats the ground plane – current flows in a big loop, becomes antenna and magnetic loop**

No Easy Fixes for Most Equipment Shielding Failures

- Scrape the paint to close slot openings**
- Bond cable shields to the case**
- Most other shielding problems usually require a complete rebuild**
- Return to manufacturer as defective**
- Give it the bucket treatment ******

If You're The Equipment Designer

- **Shield the equipment**

or:

- **Add a ground plane on a second layer**
 - **Each circuit trace is now a transmission line**
 - **Current returns on ground plane under trace**
 - **Minimizes the loop area**
 - **Minimizes antenna action**
 - **Microstrip (one ground plane)**
 - **Stripline (two ground planes sandwich the trace)**

If You're The Equipment Designer

- **BUT – microstrip and stripline don't work if the reference plane is broken under the trace**

Equipment/System Design Issues

- **Magnetic Coupling**
- **Circuit Layout Issues**
- **Fast Rise Times**

The Problems With Rise Time

- **RF trash proportional to switching speed**
- **Good RFI design = slow down the rise times of large pulsed currents**
- **Fast switching = lower power dissipation**
- **These are conflicting requirements**
- **Small rounding of waveform can greatly reduce RFI with little effect on dissipation**